

Bilge float switch

For the shipbuilding industry

Model RLS-5000 (model with approval: SR 6)

WIKA data sheet LM 50.08



For further approvals
see page 3

Applications

- Shipbuilding
- Bilge water management
- Applications with strong mechanical loading
- Contaminated media

Special features

- Robust stainless steel case to protect against mechanical damage
- Durable and resistant marine cable
- With manual test device (optional)



Bilge float switch with test device, model RLS-5000

Description

The model RLS-5000 bilge float switch is used for the monitoring of limit levels in shipbuilding (e.g. in bilge water tanks) and industrial applications. The robust stainless steel case and the durable marine cable outlet protect the float system even under high mechanical loading, e.g. due to flotsam such as sticks and pieces of wood. Inside the stainless steel case, a permanent magnet built into the float triggers, with its magnetic field, the potential-free reed contact built into the pipe.







The triggering of the reed contact by the permanent magnet is contact-free and thus free from wear. The reed switch function is freely definable as normally closed, normally open or change-over contact. In the event of maintenance, the optionally available test device enables the manual triggering of the float by a movable wire bracket.

With its optimised mechanical design and certification in accordance with the leading maritime standards, the RLS-5000 is particularly suitable for long-term and reliable use in shipbuilding applications.

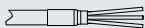
Specifications

Bilge float switch, model RLS-5000	
Measuring principle	Potential-free switching reed contact is triggered by a magnet in the float.
Switching output	Alternatively normally open (NO), normally closed (NC) or change-over (SPDT) contact - on rising level
Switch position	see "Dimensions in mm [in]"
Switching power	Normally open, normally closed: AC 230 V; 100 VA; 1 A DC 230 V; 50 W; 0.5 A Change-over contact: AC 230 V; 40 VA; 1 A DC 230 V; 20 W; 0.5 A
Test device	For manual triggering of the float/switch contact (optional)
Accuracy	±3 mm switch point accuracy incl. hysteresis, non-repeatability
Electrical connection	Cable outlet, IP68 (8 m [26.2 ft]) Cable length freely definable in in m/ft
Protection class	II
Mounting position	Vertical ±30°
Process connection	Surface mounting lug with 2 drilled holes D = 7.0 mm [0.3 in] Hole centre spacing = 34 mm [1.3 in]
Material	<ul style="list-style-type: none"> ■ Case, pipe, surface mounting lug, float ■ Cable
Permissible temperatures	<ul style="list-style-type: none"> ■ Medium ■ Ambient ■ Storage
Process pressure	max. 16 bar [232 psi]
Medium density	≥ 750 kg/m ³ [46.8 lbs/ft ³]

Connection diagram

Cable outlet		
	Normally open/normally closed (NO/NC)	Change-over contact (SPDT)
	BU  BN 	BK  BN  GY 

Legend



SP1 - SP4	Switch points	BU	Blue
WH	White	RD	Red
BN	Brown	BK	Black
GN	Green	VT	Violet
YE	Yellow	GYPK	Grey/Pink
GY	Grey	RDBU	Red/Blue
PK	Pink		

Electrical safety	
Insulation voltage	DC 2,120 V

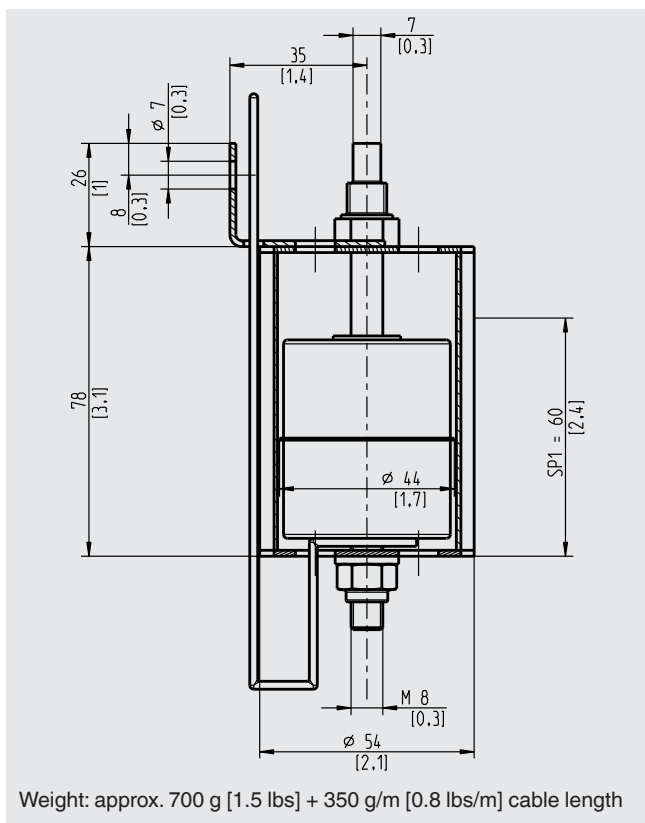
Dimensions in mm [in]



Approvals

Logo	Description	Country
	EU declaration of conformity	Europäische Union
	Low voltage directive	
	RoHS directive	
	DNV GL Schiffe, Schiffbau (z. B. Offshore)	International

Approvals and certificates, see website

Manufacturer's information and certificates

Logo	Description
-	China-RoHS-Richtlinie

Ordering information

Model / Switching function / Cable length / Test device (optional)

© 01/2017 WIKA Alexander Wiegand SE & Co. KG, all rights reserved.
The specifications given in this document represent the state of engineering at the time of publishing.
We reserve the right to make modifications to the specifications and materials.

