

# High-pressure connection adapters and couplings

## Nominal pressure of 15,000 ... 60,000 psi [1,034 ... 4,136 bar]

### Model HPAC

WIKA data sheet AC 09.33

#### Applications

- Oil and gas, chemical industry, machine building and automation
- For injection systems, test benches and hydraulic power packs
- Blasting/cutting with water, high-pressure cleaning

#### Special features

- One-piece design
- Laser marked for identification
- Large selection of materials and configurations available
- Customer-specific combination of adapters, fittings, valves and measuring instruments (instrument hook-up) on request



Examples of connection adapters and couplings

#### Description

The model HPAC high-pressure connection adapters and couplings have been developed for high-pressure applications of 15,000 ... 60,000 psi [1,034 ... 4,136 bar]. The connection adapters and couplings are particularly suitable for a safe connection to high-pressure valves, nipples and fittings, even in control panels, where the space is restricted, or in test benches.

A wide range of connection adapters and couplings is available, including male-female, male-male or female-female, with NPT threads or as cone/thread (C&T) version.

The design and the use of high-quality materials ensure long operating times and high leak tightness.

Carefully packed, damage is prevented in particular by thread protective caps on the external threads. Every adapter is laser marked for identification with article number, nominal pressure, connection size and more details.

On request, WIKAI offers the professional assembly of valves and pressure measuring instruments and also other accessories into a ready-to-install instrument hook-up. To ensure the functionality of the complete system, an additional leak test is carried out on the instrument hook-up.

## Specifications

Model HPAC	
<b>Adapter type</b>	<ul style="list-style-type: none"> <li>■ Female-male connection adapter</li> <li>■ Male-male connection adapter</li> <li>■ Female-female connection coupling</li> </ul>
<b>Nominal pressure</b>	<ul style="list-style-type: none"> <li>■ 15,000 psi [1,034 bar]</li> <li>■ 20,000 psi [1,379 bar]</li> <li>■ 60,000 psi [4,136 bar]</li> </ul>
<b>Connection type</b>	<ul style="list-style-type: none"> <li>■ Thread per ANSI / ASME B1.20.1, code NPT</li> <li>■ Cone/thread (C&amp;T) <sup>1)</sup></li> </ul>
<b>Connection size</b>	
15,000 psi [1,034 bar]	<ul style="list-style-type: none"> <li>■ ¼ NPT</li> <li>■ ⅜ NPT</li> <li>■ ½ NPT</li> </ul>
20,000 psi [1,379 bar]	<ul style="list-style-type: none"> <li>■ ¼" cone/thread (C&amp;T)</li> <li>■ ⅜" cone/thread (C&amp;T)</li> <li>■ ½" cone/thread (C&amp;T)</li> </ul>
60,000 psi [4,136 bar]	<ul style="list-style-type: none"> <li>■ ¼" cone/thread (C&amp;T)</li> <li>■ ⅜" cone/thread (C&amp;T)</li> <li>■ ½" cone/thread (C&amp;T)</li> </ul>
<b>Features</b>	<ul style="list-style-type: none"> <li>■ 100 % traceability of the parts</li> </ul>

1) Adapters with cone/thread (C&T) connections are not supplied with gland collars and glands. These can be supplied assembled in the female connection on request.

→ For available combinations of adapter type, connection type and size, see from page 3

### Important notice

If the two connection sides have different rated pressures, the nominal pressure of the connection adapter will be decreased to the lower value.

Materials	
<b>Wetted parts</b>	<ul style="list-style-type: none"> <li>■ Stainless steel 316 (1.4401)</li> <li>■ Stainless steel 316L (1.4404)</li> <li>■ Other materials on request</li> </ul>

## Dimensions in mm [in]

**Female-male connection adapter**  
Nominal pressure: 15,000 psi [1,034 bar]

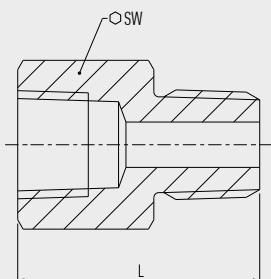

Side 1 15,000 psi [1,034 bar]	Side 2 15,000 psi [1,034 bar]	Dimensions in mm [in]	
		SW	L
¼ NPT	¼ NPT	19.05 [0.75]	33 [1.3]
¼ NPT	⅜ NPT	19.05 [0.75]	37 [1.46]
¼ NPT	½ NPT	23.8 [0.94]	40 [1.58]
⅜ NPT	¼ NPT	25.4 [1]	35 [1.38]
⅜ NPT	⅜ NPT	25.4 [1]	37 [1.46]
⅜ NPT	½ NPT	25.4 [1]	40 [1.58]
½ NPT	¼ NPT	30.16 [1.19]	41 [1.61]
½ NPT	⅜ NPT	30.16 [1.19]	45 [1.77]
½ NPT	½ NPT	30.16 [1.19]	48 [1.89]

**Female-male connection adapter**  
Nominal pressure: 15,000 psi [1,034 bar]

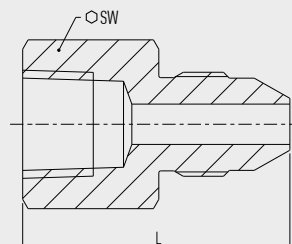

Side 1 15,000 psi [1,034 bar]	Side 2 20,000 psi [1,379 bar]	Dimensions in mm [in]	
		SW	L
¼ NPT	¼" C&T	19.05 [0.75]	37.5 [1.48]
¼ NPT	⅜" C&T	19.05 [0.75]	41.5 [1.63]
¼ NPT	⅜" C&T	22.22 [0.88]	45 [1.77]
⅜ NPT	¼" C&T	25.4 [1]	39.5 [1.56]
⅜ NPT	⅜" C&T	25.4 [1]	43.5 [1.71]
⅜ NPT	⅜" C&T	25.4 [1]	45 [1.77]
½ NPT	¼" C&T	30.16 [1.19]	45.5 [1.79]
½ NPT	⅜" C&T	30.16 [1.19]	49.5 [1.95]
½ NPT	⅜" C&T	30.16 [1.19]	53 [2.09]

**Female-male connection adapter**  
Nominal pressure: 15,000 psi [1,034 bar]

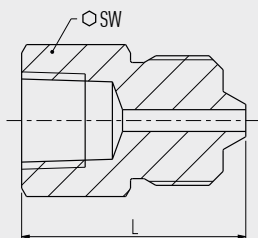

Side 1 15,000 psi [1,034 bar]	Side 2 60,000 psi [1,379 bar]	Dimensions in mm [in]	
		SW	L
¼ NPT	¼" C&T	19.05 [0.75]	36 [1.42]
¼ NPT	⅜" C&T	20.6 [0.81]	41.5 [1.63]
¼ NPT	⅜" C&T	30.16 [1.19]	44.4 [1.75]
⅜ NPT	¼" C&T	35.4 [1.39]	38 [1.50]
⅜ NPT	⅜" C&T	25.4 [1]	41.5 [1.63]
⅜ NPT	⅜" C&T	30.16 [1.19]	44.4 [1.75]
½ NPT	¼" C&T	30.16 [1.19]	44 [1.73]
½ NPT	⅜" C&T	30.16 [1.19]	49.5 [1.95]
½ NPT	⅜" C&T	30.16 [1.19]	49.4 [1.94]

**Female-male connection adapter**  
Nominal pressure: 15,000 psi [1,034 bar]

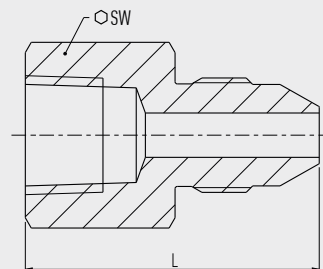

Side 1 20,000 psi [1,379 bar]	Side 2 15,000 psi [1,034 bar]	Dimensions in mm [in]	
		SW	L
¼" C&T	¼ NPT	15.9 [0.62]	30 [1.18]
¼" C&T	⅜ NPT	19.05 [0.75]	34 [1.34]
¼" C&T	½ NPT	23.8 [0.94]	37 [1.46]
⅜" C&T	¼ NPT	19.05 [0.75]	38 [1.50]
⅜" C&T	⅜ NPT	19.05 [0.75]	37 [1.46]
⅜" C&T	½ NPT	23.8 [0.94]	40 [1.58]
⅜" C&T	¼ NPT	25.4 [1]	45 [1.77]
⅜" C&T	⅜ NPT	25.4 [1]	49 [1.93]
⅜" C&T	½ NPT	25.4 [1]	46 [1.81]

**Female-male connection adapter**  
**Nominal pressure: 15,000 psi [1,034 bar]**

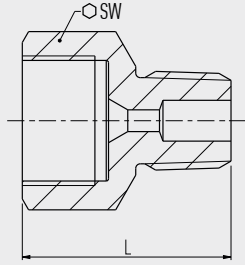

Side 1 60,000 psi [1,379 bar]	Side 2 15,000 psi [1,034 bar]	Dimensions in mm [in]	
		SW	L
¼" C&T	¼" NPT	19.05 [0.75]	29 [1.14]
¼" C&T	⅜" NPT	19.05 [0.75]	33 [1.3]
¼" C&T	½" NPT	23.8 [0.94]	37 [1.46]
⅜" C&T	¼" NPT	25.4 [1]	35 [1.38]
⅜" C&T	⅜" NPT	25.4 [1]	37 [1.46]
⅜" C&T	½" NPT	25.4 [1]	40 [1.57]
⅝" C&T	¼" NPT	34.93 [1.38]	41 [1.61]
⅝" C&T	⅜" NPT	34.93 [1.38]	44 [1.73]
⅝" C&T	½" NPT	34.93 [1.38]	46 [1.81]

**Female-male connection adapter**  
**Nominal pressure: 20,000 psi [1,379 bar]**

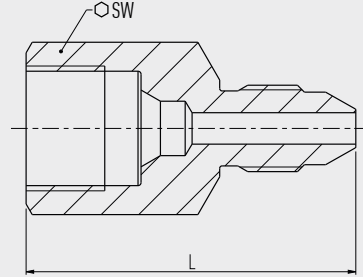

Side 1 20,000 psi [1,379 bar]	Side 2 20,000 psi [1,379 bar]	Dimensions in mm [in]	
		SW	L
¼" C&T	¼" C&T	15.9 [0.62]	34.5 [1.36]
¼" C&T	⅜" C&T	15.9 [0.62]	38.5 [1.52]
¼" C&T	⅝" C&T	22.2 [0.87]	42 [1.65]
⅜" C&T	¼" C&T	19.05 [0.75]	43.5 [1.71]
⅜" C&T	⅜" C&T	19.05 [0.75]	41.5 [1.63]
⅜" C&T	⅝" C&T	22.2 [0.87]	45 [1.78]
⅝" C&T	¼" C&T	25.4 [1]	50.5 [1.99]
⅝" C&T	⅜" C&T	25.4 [1]	54.5 [2.15]
⅝" C&T	⅝" C&T	25.4 [1]	51 [2.01]

**Female-male connection adapter**  
**Nominal pressure: 20,000 psi [1,379 bar]**

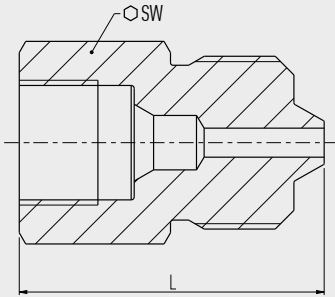

Side 1 20,000 psi [1,379 bar]	Side 2 60,000 psi [1,379 bar]	Dimensions in mm [in]	
		SW	L
¼" C&T	¼" C&T	15.9 [0.62]	33 [1.3]
¼" C&T	⅜" C&T	20.6 [0.81]	38.5 [1.52]
¼" C&T	⅝" C&T	30.16 [1.19]	42.4 [1.67]
⅜" C&T	¼" C&T	19.05 [0.75]	42 [1.65]
⅜" C&T	⅜" C&T	30.64 [1.21]	41.5 [1.63]
⅜" C&T	⅝" C&T	30.16 [1.19]	42.4 [1.67]
⅝" C&T	¼" C&T	25.4 [1]	47 [1.85]
⅝" C&T	⅜" C&T	25.4 [1]	50 [1.97]
⅝" C&T	⅝" C&T	30.16 [1.19]	50.4 [1.98]

**Female-male connection adapter**  
**Nominal pressure: 20,000 psi [1,379 bar]**

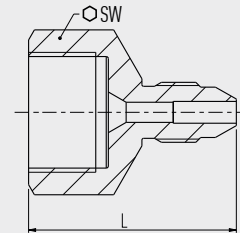

Side 1 60,000 psi [1,379 bar]	Side 2 20,000 psi [1,379 bar]	Dimensions in mm [in]	
		SW	L
¼" C&T	¼" C&T	19.05 [0.75]	33.5 [1.32]
¼" C&T	⅜" C&T	19.05 [0.75]	37.5 [1.48]
¼" C&T	⅝" C&T	22.2 [0.87]	41 [1.61]
⅜" C&T	¼" C&T	25.4 [1]	39.5 [1.56]
⅜" C&T	⅜" C&T	25.4 [1]	43.5 [1.71]
⅜" C&T	⅝" C&T	25.4 [1]	45 [1.78]
⅝" C&T	¼" C&T	34.93 [1.38]	50 [1.97]
⅝" C&T	⅜" C&T	34.93 [1.38]	49.5 [1.95]
⅝" C&T	⅝" C&T	34.93 [1.38]	51 [2.01]

**Female-male connection adapter**  
**Nominal pressure: 60,000 psi [1,379 bar]**

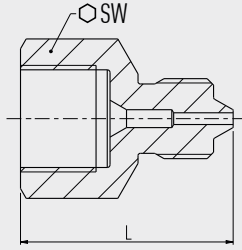

Side 1 60,000 psi [1,379 bar]	Side 2 60,000 psi [1,379 bar]	Dimensions in mm [in]	
		SW	L
¼" C&T	¼" C&T	19.05 [0.75]	32 [1.26]
¼" C&T	⅜" C&T	20.6 [0.81]	37.5 [1.48]
¼" C&T	⅝" C&T	30.16 [1.19]	42.4 [1.67]
⅜" C&T	¼" C&T	25.4 [1]	38 [1.5]
⅜" C&T	⅜" C&T	25.4 [1]	41.5 [1.63]
⅜" C&T	⅝" C&T	30.16 [1.19]	44.4 [1.75]
⅝" C&T	¼" C&T	34.93 [1.38]	47 [1.85]
⅝" C&T	⅜" C&T	34.93 [1.38]	47.5 [1.87]
⅝" C&T	⅝" C&T	34.93 [1.38]	50.4 [1.98]

**Male-male connection adapter**  
**Nominal pressure: 15,000 psi [1,034 bar]**

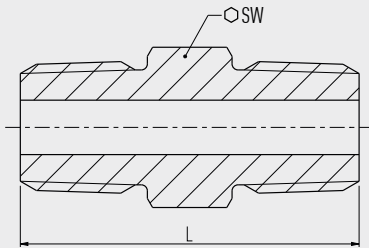

Side 1 15,000 psi [1,034 bar]	Side 2 15,000 psi [1,034 bar]	Dimensions in mm [in]	
		SW	L
¼ NPT	¼ NPT	15.9 [0.62]	38 [1.5]
¼ NPT	⅜ NPT	19.1 [0.75]	45 [1.78]
¼ NPT	½ NPT	23.8 [0.94]	51 [2.01]
⅜ NPT	⅜ NPT	23.8 [0.94]	53 [2.09]
⅜ NPT	½ NPT	19.1 [0.75]	48 [1.89]
½ NPT	½ NPT	23.8 [0.94]	56 [2.2]

**Male-male connection adapter**  
**Nominal pressure: 15,000 psi [1,034 bar]**

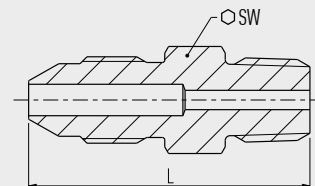

Side 1 15,000 psi [1,034 bar]	Side 2 20,000 psi [1,379 bar]	Dimensions in mm [in]	
		SW	L
¼ NPT	¼" C&T	15.9 [0.62]	44 [1.73]
¼ NPT	⅜" C&T	15.9 [0.62]	46.5 [1.83]
¼ NPT	⅝" C&T	22.2 [0.87]	55 [2.17]
⅜ NPT	¼" C&T	19.1 [0.75]	51.5 [2.03]
⅜ NPT	⅜" C&T	19.1 [0.75]	54.5 [2.15]
⅜ NPT	⅝" C&T	22.2 [0.87]	58 [2.28]
½ NPT	¼" C&T	23.8 [0.94]	58 [2.28]
½ NPT	⅜" C&T	23.8 [0.94]	61 [2.4]
½ NPT	⅝" C&T	23.8 [0.94]	61 [2.4]

**Male-male connection adapter**  
**Nominal pressure: 15,000 psi [1,034 bar]**

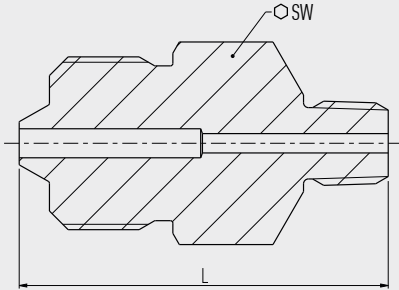

Side 1 15,000 psi [1,034 bar]	Side 2 60,000 psi [1,379 bar]	Dimensions in mm [in]	
		SW	L
¼ NPT	¼" C&T	15.9 [0.62]	41 [1.61]
¼ NPT	⅜" C&T	20.6 [0.81]	48.5 [1.91]
¼ NPT	⅝" C&T	30.2 [1.19]	61 [2.4]
⅜ NPT	¼" C&T	19.1 [0.75]	47 [1.85]
⅜ NPT	⅜" C&T	20.6 [0.81]	25.5 [1]
⅜ NPT	⅝" C&T	30.2 [1.19]	64 [2.52]
½ NPT	¼" C&T	23.8 [0.94]	52 [2.05]
½ NPT	⅜" C&T	23.8 [0.94]	57.5 [2.26]
½ NPT	⅝" C&T	30.2 [1.19]	65.5 [2.58]

**Male-male connection adapter**  
**Nominal pressure: 20,000 psi [1,379 bar]**

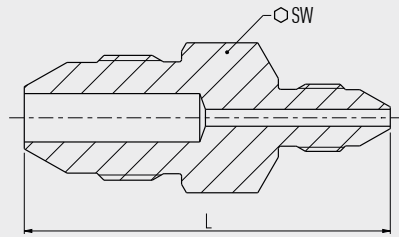

Side 1 20,000 psi [1,379 bar]	Side 2 20,000 psi [1,379 bar]	Dimensions in mm [in]	
		SW	L
¼" C&T	¼" C&T	12.7 [0.5]	45 [1.77]
¼" C&T	⅜" C&T	15.9 [0.62]	52.5 [2.07]
¼" C&T	⅝" C&T	22.2 [0.87]	60.5 [2.38]
⅜" C&T	⅜" C&T	18.9 [0.74]	55 [2.17]
⅜" C&T	⅝" C&T	22.2 [0.87]	63.5 [2.5]
⅝" C&T	⅝" C&T	22.2 [0.87]	64 [2.52]

**Male-male connection adapter**  
**Nominal pressure: 20,000 psi [1,379 bar]**

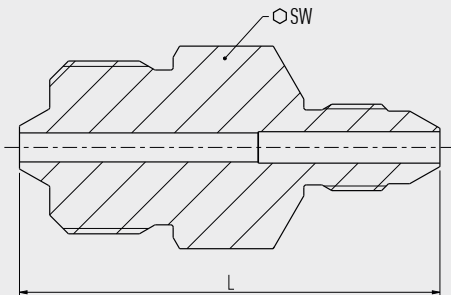

Side 1 20,000 psi [1,379 bar]	Side 2 60,000 psi [1,379 bar]	Dimensions in mm [in]	
		SW	L
¼" C&T	¼" C&T	15.9 [0.62]	45.5 [1.79]
¼" C&T	⅜" C&T	20.6 [0.81]	56.5 [2.22]
¼" C&T	⅝" C&T	30.2 [1.19]	65.5 [2.58]
⅜" C&T	¼" C&T	15.9 [0.62]	49.5 [1.95]
⅜" C&T	⅜" C&T	20.6 [0.81]	59.5 [2.34]
⅜" C&T	⅝" C&T	30.2 [1.19]	69.5 [2.74]
⅝" C&T	¼" C&T	22.2 [0.87]	58 [2.28]
⅝" C&T	⅜" C&T	22.2 [0.87]	60.5 [2.38]
⅝" C&T	⅝" C&T	30.2 [1.19]	67.4 [2.65]

**Male-male connection adapter**  
**Nominal pressure: 60,000 psi [1,379 bar]**

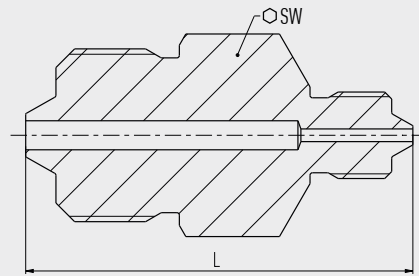

Side 1 60,000 psi [1,379 bar]	Side 2 60,000 psi [1,379 bar]	Dimensions in mm [in]	
		SW	L
¼" C&T	¼" C&T	15.9 [0.62]	44 [1.73]
¼" C&T	⅜" C&T	20.6 [0.81]	54 [2.13]
¼" C&T	⅝" C&T	30.2 [1.19]	64 [2.52]
⅜" C&T	¼" C&T	20.6 [0.81]	57 [2.24]
⅜" C&T	⅜" C&T	30.2 [1.19]	68 [2.68]
⅝" C&T	⅝" C&T	30.2 [1.19]	66.8 [2.63]

**Female-female connection coupling**  
**Nominal pressure: 15,000 psi [1,034 bar]**

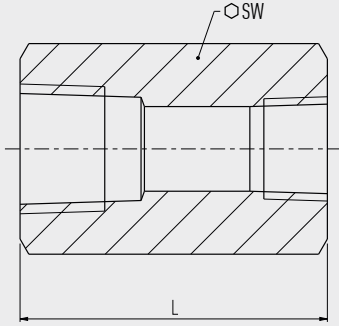

Side 1 15,000 psi [1,034 bar]	Side 2 15,000 psi [1,034 bar]	Dimensions in mm [in]	
		SW	L
¼ NPT	¼ NPT	19.1 [0.75]	38.1 [1.5]
¼ NPT	⅜ NPT	25.4 [1]	41.3 [1.63]
¼ NPT	½ NPT	30.2 [1.19]	50.8 [2]
⅜ NPT	⅜ NPT	25.4 [1]	41.3 [1.63]
⅜ NPT	½ NPT	30.2 [1.19]	50.8 [2]
½ NPT	½ NPT	30.2 [1.19]	50.8 [2]

**Female-female connection coupling**  
**Nominal pressure: 15,000 psi [1,034 bar]**

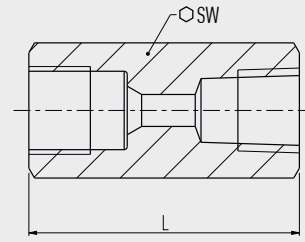

Side 1 15,000 psi [1,034 bar]	Side 2 20,000 psi [1,379 bar]	Dimensions in mm [in]	
		SW	L
¼ NPT	¼" C&T	19.1 [0.75]	61 [2.4]
¼ NPT	⅜" C&T	19.1 [0.75]	44 [1.73]
¼ NPT	⅝" C&T	25.4 [1]	44 [1.73]
⅜ NPT	¼" C&T	25.4 [1]	44 [1.73]
⅜ NPT	⅜" C&T	25.4 [1]	44 [1.73]
⅜ NPT	⅝" C&T	25.4 [1]	44 [1.73]
½ NPT	¼" C&T	30.2 [1.19]	50.8 [2]
½ NPT	⅜" C&T	30.2 [1.19]	50.8 [2]
½ NPT	⅝" C&T	30.2 [1.19]	49 [1.93]

**Female-female connection coupling**  
**Nominal pressure: 20,000 psi [1,379 bar]**

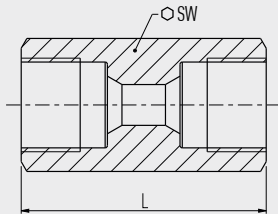

Side 1 20,000 psi [1,379 bar]	Side 2 20,000 psi [1,379 bar]	Dimensions in mm [in]	
		SW	L
¼" C&T	¼" C&T	15.9 [0.63]	41 [1.61]
¼" C&T	⅜" C&T	19.1 [0.75]	41 [1.61]
⅜" C&T	⅜" C&T	19.1 [0.75]	45 [1.78]
⅜" C&T	⅝" C&T	25.4 [1]	50.8 [2]
⅝" C&T	⅝" C&T	25.4 [1]	54 [2.13]

**Female-female connection coupling**  
**Nominal pressure: 60,000 psi [1,379 bar]**

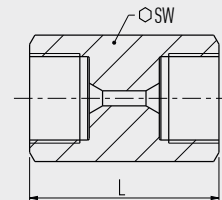

Side 1 60,000 psi [1,379 bar]	Side 2 60,000 psi [1,379 bar]	Dimensions in mm [in]	
		SW	L
¼" C&T	¼" C&T	25.4 [1]	44.5 [1.75]
¼" C&T	⅜" C&T	25.4 [1]	49 [1.93]
¼" C&T	⅝" C&T	34.9 [1.37]	45 [1.78]
⅜" C&T	⅜" C&T	25.4 [1]	50.8 [2]
⅜" C&T	⅝" C&T	34.9 [1.37]	49 [1.93]
⅝" C&T	⅝" C&T	34.9 [1.37]	60.3 [2.38]

## Certificates

- 3.1 inspection certificate per EN 10204 (option)  
Material certificate for all wetted parts

## Ordering information

Model / Adapter type / Connection type / Connection size / Material / Options

© 05/2022 WIKA Alexander Wiegand SE & Co. KG, all rights reserved.  
The specifications given in this document represent the state of engineering at the time of publishing.  
We reserve the right to make modifications to the specifications and materials.