

Thermocouple Industrial assembly Model TC10-0

WIKA data sheet TE 66.01



for further approvals
see page 2

Applications

- Chemical and petrochemical industries
- Machinery, plant and tank measurement
- Oil and gas industries
- Power and utilities
- Pulp and paper

Special features

- Sensor ranges from -40 ... +1,260 °C [-40 ... +2,300 °F]
- For mounting in all standard thermowell designs
- Spring-loaded measuring insert (replaceable)
- Explosion-protected versions
- Fixed fitting (welded) measuring insert



Thermocouple, model TC10-0, industrial assembly

Description

Thermocouples in this series can be combined with a large number of thermowell designs. Use without a thermowell is permitted when using a fixed (welded) fitting.

A wide variety of possible combinations of sensor, connection head, insertion length, neck length, connection to thermowell etc. are available for the thermometers; suitable for almost any thermowell dimension.

Representation of the components

Tapered threads

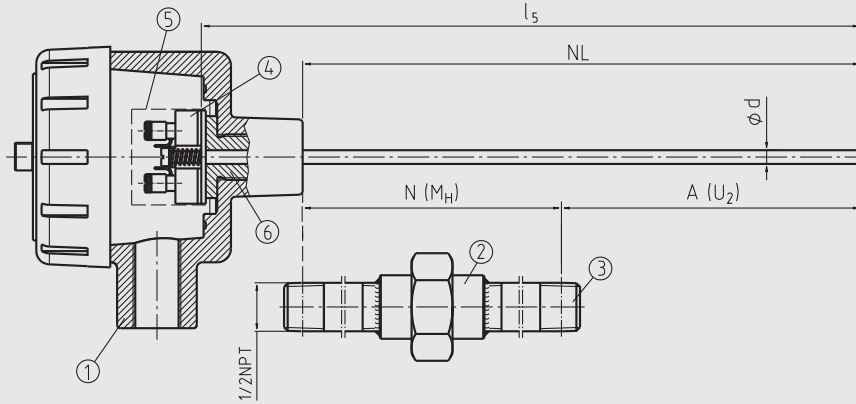

3112147.02

Parallel threads

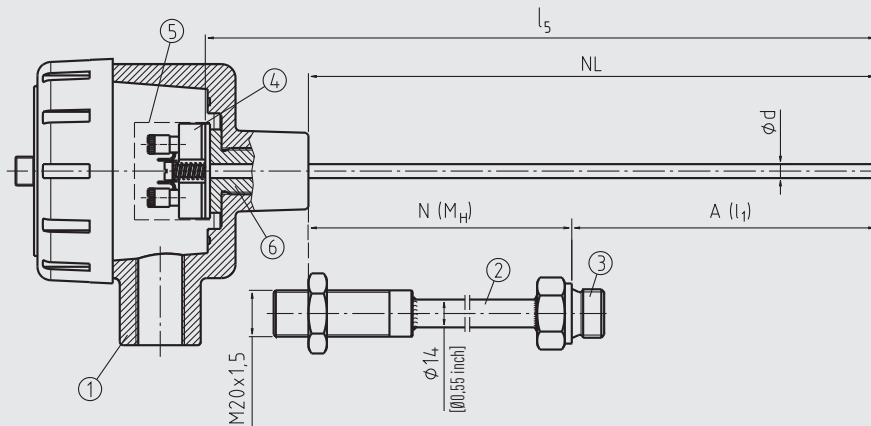

3112287.01

Legend:

- | | |
|----------------------------|---|
| ① Connection head | A (U ₂) Insertion length (tapered threads) |
| ② Neck tube | A (l ₁) Insertion length (parallel threads) |
| ③ Connection to thermowell | l ₅ Measuring insert length |
| ④ Measuring insert | Ø d Measuring insert diameter |
| ⑤ Transmitter (option) | NL Nominal length |
| ⑥ Flame path fitting | N (M _H) Neck length |

Overview of approvals for explosion protection

Approval	Explosion protection					
	Ex i (gas) Zone 0, 1, 2	Ex i (dust) Zone 20, 21, 22	Ex d (gas) Zone 1, 2	Ex d (dust) Zone 21	Ex e (gas) Zone 1, 2	Ex n (gas) Zone 2
ATEX	x	x	x	x	x	x
IECEX	x	x	x	x	x	x
FM	-	-	x	x	-	-
CSA	-	-	x	x	-	-
EAC	x	x	x	x	-	x
Ex Ukraine	x	x	x	x	-	-
INMETRO	x	x	-	-	-	-
CCC	x	x	x	x	x	x

→ For detailed information, see page 11

Measuring element

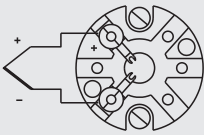
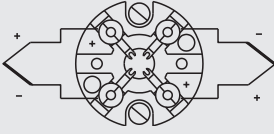
Measuring element		
Type of sensor	Thermocouple per IEC 60584-1 or ASTM E230 Types K, J, E, N, T	
Hot junction	<ul style="list-style-type: none"> ■ Ungrounded (standard) ■ Grounded (welded to the sheath) 	
Marking of the polarity	The colour coding at the positive poles of the instrument decides the correlation of polarity and terminal	
Single thermocouple		
Dual thermocouple		
Validity limits of the class accuracy per EN 60584-1		
Type K	Class 2	-40 ... +1,200 °C [-40 ... +2,192 °F]
	Class 1	-40 ... +1,000 °C [-40 ... +1,832 °F]
Type J	Class 2	-40 ... +750 °C [-40 ... +1,382 °F]
	Class 1	-40 ... +750 °C [-40 ... +1,382 °F]
Type E	Class 2	-40 ... +900 °C [-40 ... +1,652 °F]
	Class 1	-40 ... +800 °C [-40 ... +1,472 °F]
Type N	Class 2	-40 ... +1,200 °C [-40 ... +2,192 °F]
	Class 1	-40 ... +1,000 °C [-40 ... +1,832 °F]
Type T	Class 2	-40 ... +350 °C [-40 ... +662 °F]
	Class 1	-40 ... +350 °C [-40 ... +662 °F]
Validity limits of the class accuracy in accordance with ASTM-E230		
Type K	Standard	0 ... 1,260 °C [32 ... 2,300 °F]
	Special	0 ... 1,260 °C [32 ... 2,300 °F]
Type J	Standard	0 ... 760 °C [32 ... 1,400 °F]
	Special	0 ... 760 °C [32 ... 1,400 °F]
Type E	Standard	0 ... 870 °C [32 ... 1,598 °F]
	Special	0 ... 870 °C [32 ... 1,598 °F]
Type N	Standard	0 ... 1,260 °C [32 ... 2,300 °F]
	Special	0 ... 1,260 °C [32 ... 2,300 °F]
Type T	Standard	0 ... 370 °C [32 ... 698 °F]
	Special	0 ... 370 °C [32 ... 698 °F]

→ For detailed specifications for thermocouples, see IEC 60584-1 or ASTM E230 and Technical Information IN 00.23 at www.wika.com.

The table shows the temperature ranges listed in the respective standards, in which the tolerance values (class accuracies) are valid.

The actual operating temperature of the thermometer is limited both by the maximum permissible working temperature and the diameter of both the thermocouple and the sheathed cable, as well as by the maximum permissible working temperature of the thermowell material.

For the tolerance value of thermocouples, a cold junction temperature of 0 °C has been taken as the basis.

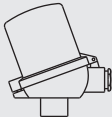

Connection head

European designs per EN 50446 / DIN 43735

Model	Material	Cable entry thread size	Ingress protection (max.) ¹⁾ IEC/EN 60529	Cap	Surface	Connection to neck tube
 BS	Aluminium	<ul style="list-style-type: none"> ■ M20 x 1.5 ■ ½ NPT 	IP65 ²⁾	Flat cover with 2 screws	Blue, painted (RAL 5022)	<ul style="list-style-type: none"> ■ M24 x 1.5 ■ ½ NPT
 BSZ-H	Aluminium	<ul style="list-style-type: none"> ■ M20 x 1.5 ■ ½ NPT 	IP65 ²⁾	Raised hinged cover with cylinder head screw	Blue, painted (RAL 5022)	<ul style="list-style-type: none"> ■ M24 x 1.5 ■ ½ NPT

Model	Explosion protection				
	Without	Ex i (gas) Zone 0, 1, 2	Ex i (dust) Zone 20, 21, 22	Ex e (gas) Zone 1, 2	Ex t (dust) Zone 21, 22
BS	x	x	-	-	-
BSZ-H	x	x	x	x ³⁾	x ³⁾

North American designs

Model	Material	Cable entry thread size	Ingress protection (max.) ¹⁾ IEC/EN 60529	Cap	Surface	Connection to neck tube
 KN4-A	Aluminium	<ul style="list-style-type: none"> ■ ½ NPT ■ M20 x 1.5 	IP65 ²⁾	Screw-on lid	Blue, painted (RAL 5022)	<ul style="list-style-type: none"> ■ M24 x 1.5 ■ ½ NPT
	KN4-P⁴⁾	Polypropylene	½ NPT	IP65 ²⁾	Screw-on lid	White
 1/4000 F	Aluminium	<ul style="list-style-type: none"> ■ ½ NPT ■ ¾ NPT ■ M20 x 1.5 	IP66 ²⁾	Screw-on lid	Blue, painted (RAL 5022)	½ NPT
	1/4000 S	Stainless steel	<ul style="list-style-type: none"> ■ ½ NPT ■ ¾ NPT ■ M20 x 1.5 	IP66 ²⁾	Screw-on lid	Natural finish
 7/8000 W	Aluminium	<ul style="list-style-type: none"> ■ ½ NPT ■ ¾ NPT ■ M20 x 1.5 	IP66 ²⁾	Screw-on lid	Blue, painted (RAL 5022)	½ NPT
	7/8000 S	Stainless steel	<ul style="list-style-type: none"> ■ ½ NPT ■ ¾ NPT ■ M20 x 1.5 	IP66 ²⁾	Screw-on lid	Natural finish

Model	Explosion protection				
	Without	Ex i (gas) Zone 0, 1, 2	Ex i (dust) Zone 20, 21, 22	Ex t (dust) Zone 21, 22	Ex nA (gas) Zone 2
KN4-A	x	x	-	-	-
KN4-P⁴⁾	x	-	-	-	-
1/4000 F	x	x	-	-	-
1/4000 S	x	x	-	-	-
7/8000 W	x	x	-	-	-
7/8000 S	x	x	-	-	-

1) IP ingress protection of the connection head. The IP ingress protection of the complete TC10-0 instrument does not necessarily have to correspond to the connection head.

2) Ingress protections, describing temporary or permanent immersion, on request; Suitable sealing/cable gland required

3) Only ATEX and CCC

4) On request

Other connections heads are available.

Measuring insert

Measuring insert		
Versions	Vibration-resistant, sheathed cable (mineral-insulated cable, MI cable)	
Optimal heat transfer	Requirement <ul style="list-style-type: none"> ■ Correct measuring insert length ■ Correct measuring insert diameter 	
	Bore diameter of the thermowell	Max. 1 mm [0.04 in] larger than measuring insert diameter
	Gap width	For joint width > 0.5 mm [> 0.02 in] between thermowell and measuring insert: → Negative impact on heat transfer → Unfavourable response behaviour of the thermometer
Measuring insert diameter $\varnothing d$	<ul style="list-style-type: none"> ■ 3.0 mm ■ 6.0 mm ■ 8.0 mm ■ 1/8 in or 0.125 in [3.17 mm] ■ 3/16 in or 0.188 in [4.75 mm] ■ 1/4 in or 0.250 in [6.35 mm] Other measuring insert diameters on request	
Insertion length	When fitting the measuring insert into a thermowell, it is very important to determine the correct insertion length (= thermowell length for bottom thicknesses of ≤ 5.5 mm [≤ 0.22 in]). In order to ensure that the measuring insert is firmly pressed down onto the bottom of the thermowell, the insert must be spring-loaded (spring travel: 0 ... 10 mm [0 ... 0.39 in]).	
Spring travel	Max. 10 mm [0.39 in]	

Ex d version: Due to the use of a flame path fitting and its fitting tolerances, the use of standard measuring inserts for replacement requirements is not allowed!

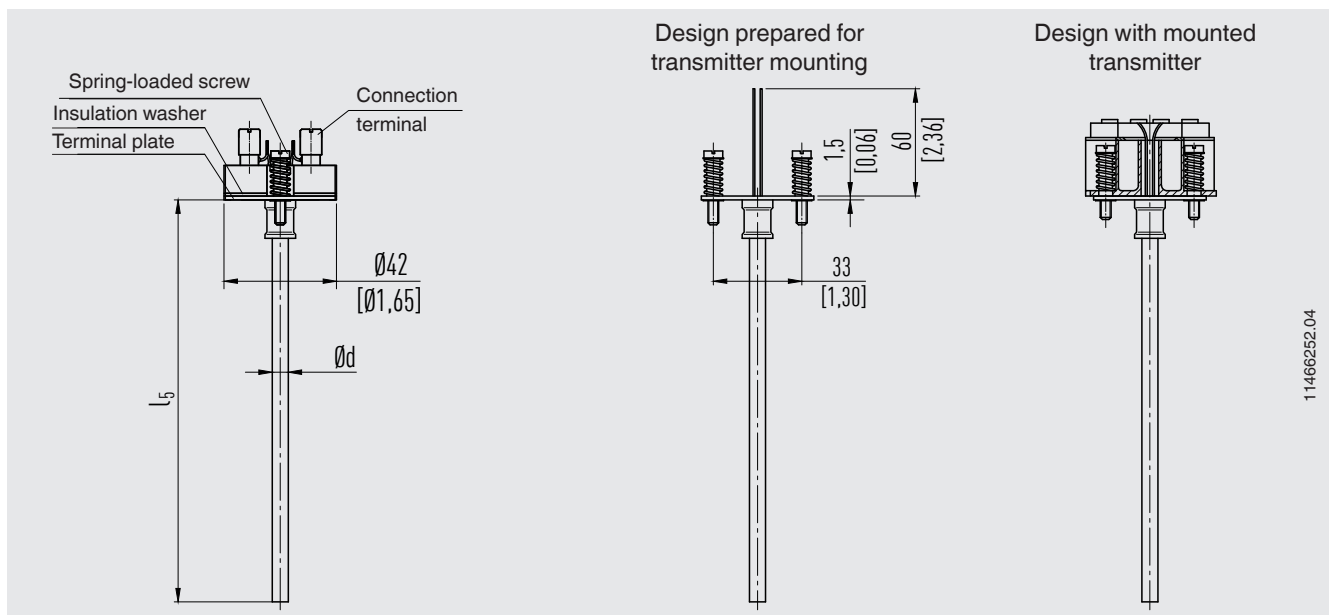

Legend:

- l_5 Measuring insert length
- $\varnothing d$ Measuring insert diameter

Transmitter

Transmitter models	Model T16	Model T32
Transmitter data sheet	TE 16.01	TE 32.04
Figure		
Output		
4 ... 20 mA	x	x
HART® protocol	-	x
Input	<ul style="list-style-type: none"> ■ Type K ■ Type J ■ Type E ■ Type N ■ Type T 	<ul style="list-style-type: none"> ■ Type K ■ Type J ■ Type E ■ Type N ■ Type T
Explosion protection	Option	Option

Possible mounting positions for transmitters	Model T16	Model T32
BS	○	-
BSZ-H	●	●
KN4-A	○	○
KN4-P	○	○
1/4000	○	○
7/8000	○	○

Legend:

- Mounted instead of terminal block
- Mounted within the cover of the connection head
- Mounting not possible

The mounting of a transmitter on the measuring insert is possible with all the connection heads listed here. The fitting of a transmitter in the (screw) cap of a North American design connection head is not possible.

Mounting of 2 transmitters on request.

For a correct determination of the overall measuring deviation, the sensor and transmitter measuring deviations must be added.

Functional safety with model T32 temperature transmitter (option)



In safety-critical applications, the entire measuring chain must be taken into consideration in terms of the safety parameters. The SIL classification allows the assessment of the risk reduction achieved by the safety installations.

Selected TC10-0 thermocouples, in combination with a suitable temperature transmitter (e.g. model T32.1S, TÜV-certified SIL version for protection systems developed in accordance with IEC 61508), are suitable as sensors for safety functions to SIL 2.

→ For detailed specifications, see Technical information IN 00.19 at www.wika.com.

Operating conditions

Operating conditions	
Ambient and storage temperature	-40 ... +80 °C [-40 ... +176 °F]
Vibration resistance	The information on vibration resistance refers to the tip of the measuring insert. → For detailed specifications on the vibration resistance of Pt100 sensors, see Technical information IN 00.17 at www.wika.de .
Standard	6 g peak-to-peak, wire-wound measuring resistor or thin film
Option	<ul style="list-style-type: none"> ■ Vibration-resistant probe tip, max. 20 g peak-to-peak, thin-film measuring resistor ■ Highly vibration-resistant probe tip, max. 50 g peak-to-peak, thin-film measuring resistor

IP ingress protection per IEC/EN 60529

First index number	Degree of protection / Short description	Test parameters
Degrees of protection against solid foreign bodies (defined by the 1st index number)		
5	Dust-protected	Per IEC/EN 60529
6	Dust-tight	Per IEC/EN 60529
Degrees of protection against water (defined by the 2nd index number)		
4	Protected against splash water	Per IEC/EN 60529
5	Protected against water jets	Per IEC/EN 60529
6	Protected against strong water jets	Per IEC/EN 60529
7 ¹⁾	Protected against the effects of temporary immersion in water	Per IEC/EN 60529
8 ¹⁾	Protected against the effects of permanent immersion in water	As agreed upon









1) Ingress protections, describing temporary or permanent immersion, on request

Standard ingress protection of model TC10-0 is IP65.

The specified degrees of protection apply under the following conditions:

- Use of a suitable thermowell
(without suitable thermowell: IP40)
- Use of a suitable cable gland
- Use of a cable cross-section appropriate for the gland or select the appropriate cable gland for the available cable
- Adhere to the tightening torques for all threaded connections

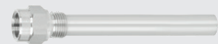
Thermowell (option)





Thermowell selection		
Model	Data sheet	Illustration
TW10	TW 95.10	
TW15	TW 95.15	
TW20	TW 95.20	
TW25	TW 95.25	
TW30	TW 95.30	
TW31	TW 95.31	
TW50	TW 95.50	
TW55	TW 95.55	









Special thermowells on request

Approvals

Logo	Description	Country
	EU declaration of conformity	European Union
	EMC directive ¹⁾	
	EN 61326 emission (group 1, class B) and immunity (industrial application)	
	RoHS directive	

Optional approvals

Logo	Description	Country				
	EU declaration of conformity ATEX directive Hazardous areas	European Union				
	- Ex i		Zone 0 gas Zone 1 mounting to zone 0 gas Zone 1 gas Zone 20 dust Zone 21 mounting to zone 20 dust Zone 21 dust	II 1G Ex ia IIC T1 ... T6 Ga II 1/2G Ex ia IIC T1 ... T6 Ga/Gb II 2G Ex ia IIC T1 ... T6 Gb II 1D Ex ia IIIC T125 ... T65 °C Da II 1/2D Ex ia IIIC T125 ... T65 °C Da/Db II 2D Ex ia IIIC T125 ... T65 °C Db		
	- Ex d		Zone 1 gas Zone 1 gas Zone 21 dust	II 2G Ex db IIB + H2 T6 ... T4 Gb II 2G Ex db IIC T6 ... T4 Gb II 2D Ex tb IIIC T85 °C Db IP66		
	- Ex e		Zone 1 gas Zone 2 gas Zone 21 dust Zone 22 dust	II 2G Ex eb IIC T1 ... T6 Gb ³⁾ II 3G Ex ec IIC T1 ... T6 Gc X II 2D Ex tb IIIC TX °C Db ³⁾ II 3D Ex tc IIIC TX °C Dc X		
	- Ex n		Zone 2 gas Zone 22 dust	II 3G Ex nA IIC T1 ... T6 Gc X II 3D Ex tc IIIC TX °C Dc X		
			IECEx - in combination with ATEX Hazardous areas	International		
			- Ex i		Zone 0 gas Zone 1 mounting to zone 0 gas Zone 1 gas Zone 20 dust Zone 21 mounting to zone 20 dust Zone 21 dust	Ex ia IIC T1 ... T6 Ga Ex ia IIC T1 ... T6 Ga/Gb Ex ia IIC T1 ... T6 Gb Ex ia IIIC T125 ... T65 °C Da Ex ia IIIC T125 ... T65 °C Da/Db Ex ia IIIC T125 ... T65 °C Db
			- Ex d		Zone 1 gas Zone 1 gas Zone 21 dust	Ex db IIB + H2 T6 ... T4 Gb Ex db IIC T6 ... T4 Gb Ex tb IIIC T85 °C Db IP66
			- Ex e ²⁾		Zone 1 gas Zone 2 gas Zone 21 dust Zone 22 dust	Ex eb IIC T1 ... T6 Gb ³⁾ Ex ec IIC T1 ... T6 Gc X Ex tb IIIC TX °C Db ³⁾ Ex tc IIIC TX °C Dc X
			- Ex n ²⁾		Zone 2 gas Zone 22 dust	Ex nA IIC T1 ... T6 Gc X Ex tc IIIC TX °C Dc X
					FM Hazardous areas	USA and Canada
					- Ex d (XP) Division 1 gas Division 1 dust	
					CSA Safety (e.g. electr. safety, overpressure, ...)	USA and Canada
Hazardous areas						
- Ex d (XP) Division 1 gas Division 1 dust Division 1 dust		Class I, division 1, groups B, C, D, T6 type 4/4X Class II, groups E, F, G Class III, T6 type 4/4X				
- Ex d (FP - CAN) Zone 1 gas - Ex d (FP - USA) Zone 1 gas Zone 1 gas		Ex d IIC Gb T6/T5/T4 Ex d IIB + H2 Gb T6/T5/T4 Class I, zone 1, AEx d IIC Gb T6/T5/T4 Class I, zone 1, AEx d IIB + H2 Gb T6/T5/T4				

Logo	Description	Country
	EAC (option) Hazardous areas - Ex i Zone 0 gas Zone 1 gas Zone 20 dust Zone 21 dust - Ex d Zone 1 gas Zone 21 dust - Ex n Zone 2 gas	Eurasian Economic Community
	Ex Ukraine Hazardous areas - Ex i Zone 0 gas Zone 1 mounting to zone 0 gas Zone 1 gas - Ex d Zone 1 gas Zone 1 gas Zone 1 mounting to zone 0 gas Zone 21 dust	Ukraine
	INMETRO Hazardous areas - Ex i Zone 0 gas Zone 1 mounting to zone 0 gas Zone 20 dust Zone 21 mounting to zone 20 dust	Brazil
	CCC ³⁾ Hazardous areas - Ex i Zone 0 gas Zone 1 gas Zone 1 mounting to zone 0 gas Zone 2 gas Zone 21 dust - Ex d Zone 1 gas Zone 1 gas Zone 21 dust - Ex e ²⁾ Zone 1 gas Zone 2 gas - Ex n ²⁾ Zone 2 gas	China
	GOST Metrology, measurement technology	Russia
	KazInMetr Metrology, measurement technology	Kazakhstan
-	MTSCHS Permission for commissioning	Kazakhstan
	BelGIM Metrology, measurement technology	Belarus
-	UkrSEPRO Metrology, measurement technology	Ukraine
	Uzstandard Metrology, measurement technology	Uzbekistan

1) Only for built-in transmitter

2) Only for connection head model BSZ, BSZ-H, 1/4000, 5/6000 or 7/8000 (see "Connection head")

3) Without transmitter

Instruments marked with "ia" may also be used in areas only requiring instruments marked with "ib" or "ic". If an instrument with "ia" marking has been used in an area with requirements in accordance with "ib" or "ic", it can no longer be operated in areas with requirements in accordance with "ia" afterwards.

Explosion protection (option)

The permissible power, P_{max} , as well as the permissible ambient temperature, for the respective category can be seen on the certificate for hazardous areas or in the operating instructions.

Attention:

Only with the correspondingly suitable components is operation in Ex hazardous areas permissible.

Transmitters have own certificates for hazardous areas. The permissible ambient temperature ranges of the built-in transmitters can be taken from the corresponding transmitter operating instructions and approvals.

Certificates (option)

Certification type	Measurement accuracy	Material certificate
2.2 test report	x	x
3.1 inspection certificate	x	x
DAkkS calibration certificate	x	-

For calibration, the measuring insert is removed from the thermometer. The minimum length (metal part of the probe) for carrying out a measurement accuracy test 3.1 or DAkkS is 100 mm [3.94 in].

Calibration of shorter lengths on request.

The different certifications can be combined with each other.

→ Approvals and certificates, see website

Connection to thermowell

The many possible designs ensure that the model TC10-0 thermocouple can be combined with almost all possible thermowells. The most usual designs of connection are shown in the following drawings; further connections on request.

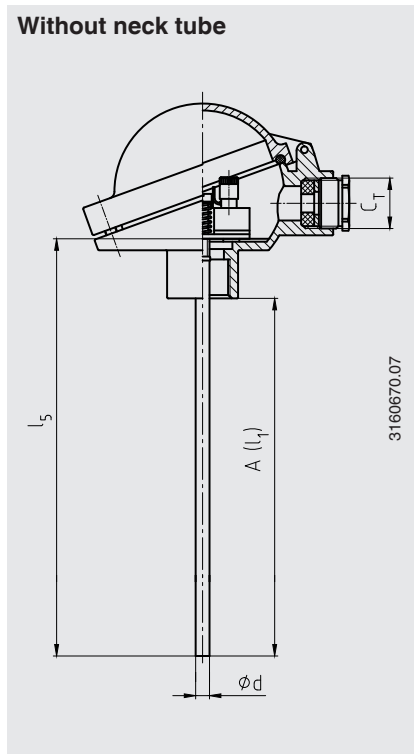
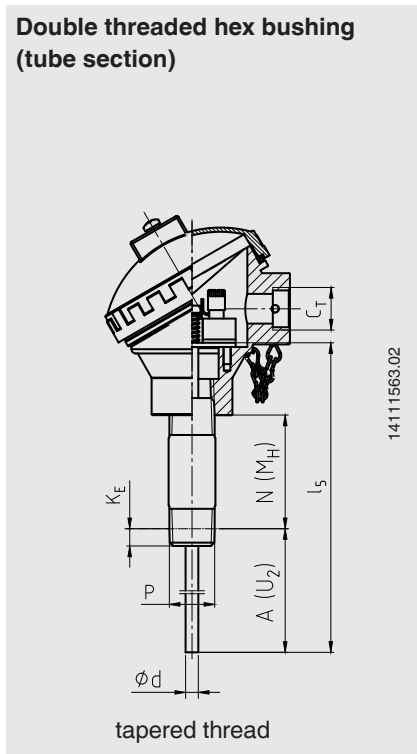
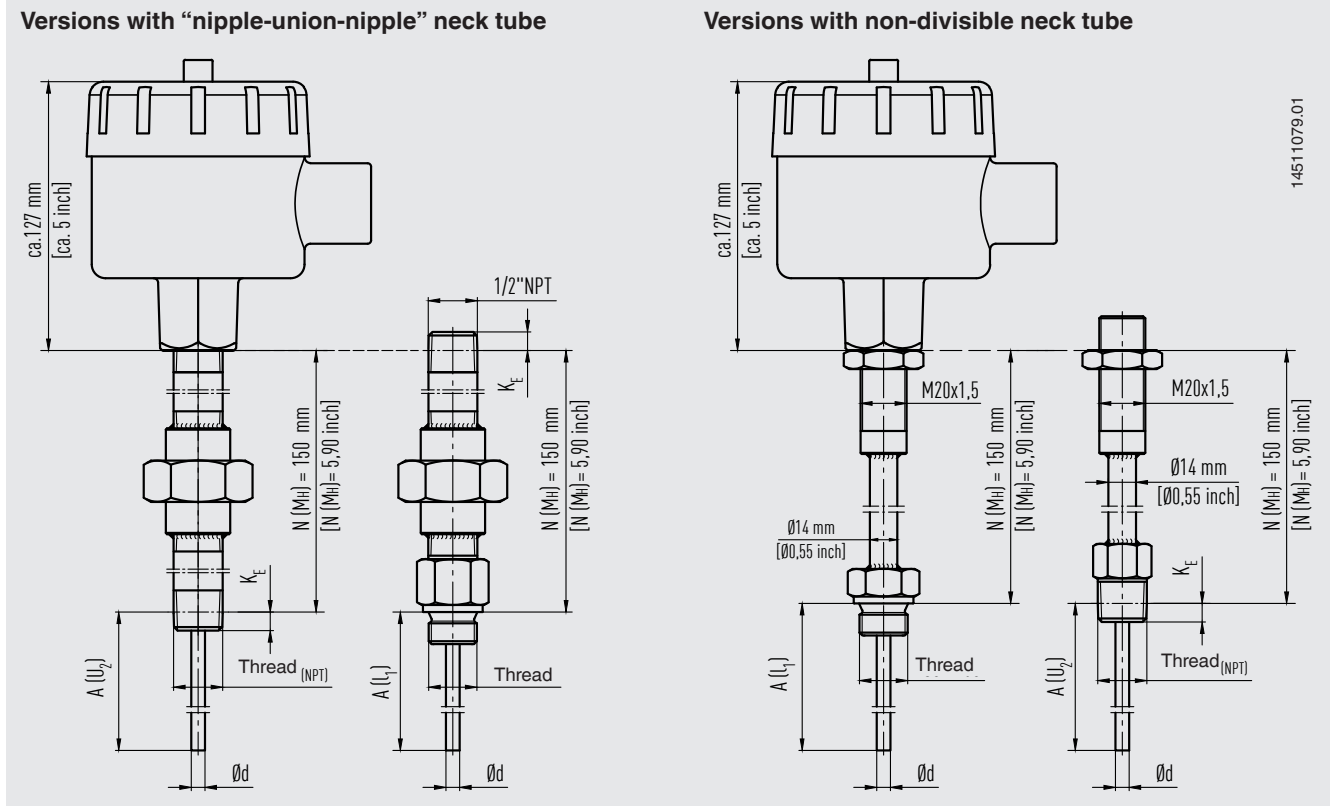

Standard thread sizes of the male threads at the neck tube

Connection thread to the thermowell

- G 1/2 B
- G 3/4 B
- M14 x 1.5
- M18 x 1.5
- 1/2 NPT
- 3/4 NPT

Connection thread to the head

- M20 x 1.5
- 1/2 NPT
- 3/4 NPT
- M24 x 1.5

Legend:

A (l₁) Insertion length (parallel threads)

A (U₂) Insertion length (tapered threads)

l₅ Measuring insert length

N (M_H) Neck length

Ø d Measuring insert diameter

C_T Thread cable entry

P Thread to the thermowell

K_E Screw-in length by hand

- with 1/2 NPT approx. 8.1 mm [0.32 in]

- with 3/4 NPT approx. 8.6 mm [0.34 in]

The figures show examples of connection heads.

Ordering information

Model / Explosion protection / Process connection / Version and material of threaded connection / Thread size / Measuring element / Connection method / Temperature range / Sensor diameter / Insertion length A / Neck length N(MH) / Certificates / Options

© 11/2021 WIKA Alexander Wiegand SE & Co. KG, all rights reserved.
The specifications given in this document represent the state of engineering at the time of publishing.
We reserve the right to make modifications to the specifications and materials.



WIKA Alexander Wiegand SE & Co. KG
Alexander-Wiegand-Straße 30
63911 Klingenberg/Germany
Tel. +49 9372 132-0
Fax +49 9372 132-406
info@wika.de
www.wika.de