

Thermocouple Flameproof joint integrated into neck tube Model TC10-W, Ex-d, for additional thermowell

WIKA data sheet TE 65.14



Applications

- Chemical industry
- Petrochemical industry
- Off-Shore
- Machine building, plant and tank construction

Special features

- Application ranges from 0 ... +1200 °C
- For many variants of temperature transmitters with displays
- For mounting in all standard thermowell designs
- Spring-loaded measuring insert (not replaceable)
- ATEX Ex-d



Thermocouple, model TC10-W, Ex-d, for additional thermowell
Option: field temperature transmitter model TIF50-F

Description

Thermocouples in this series can be combined with a large number of thermowell designs. Operation without a thermowell is only appropriate in special cases. A wide variety of possible combinations of sensor, connection head, insertion length, neck length, connection to thermowell etc. are available for the thermometers; suitable for any thermowell dimension and any application.

Sensor

Sensor type

Type	Recommended max. operating temperature
K (NiCr-Ni)	1200 °C
J (Fe-CuNi)	800 °C
E (NiCr-CuNi)	800 °C
T (Cu-CuNi)	400 °C
N (NiCrSi-NiSi)	1200 °C

The application range of these thermometers is limited both by the permissible max. temperature of the thermocouple and by the max. temperature of the thermowell material.

Listed thermocouples are available both as single or dual. The measuring point (hot junction) of the probe is supplied as ungrounded (standard version).

Tolerance value

A cold junction temperature of 0 °C is taken as the basis for the definition of the sensor tolerance value of thermocouples.

Type K

Class	Temperature range	Tolerance value
DIN EN 60584 part 2		
1	-40 ... +375 °C	±1.5 °C
1	+375 ... +1000 °C	±0.0040 • t ¹⁾
2	-40 ... +333 °C	±2.5 °C
2	+333 ... +1200 °C	±0.0075 • t ¹⁾
ISA (ANSI) MC96.1-1982		
Standard	0 ... +1250 °C	±2.2 °C or ²⁾ ±0.75 %
Special	0 ... +1250 °C	±1.1 °C or ²⁾ ±0.4 %

Type J

Class	Temperature range	Tolerance value
DIN EN 60584 part 2		
1	-40 ... +375 °C	±1.5 °C
1	+375 ... +750 °C	±0.0040 • t ¹⁾
2	-40 ... +333 °C	±2.5 °C
2	+333 ... +750 °C	±0.0075 • t ¹⁾
ISA (ANSI) MC96.1-1982		
Standard	0 ... +750 °C	±2.2 °C or ²⁾ ±0.75 %
Special	0 ... +750 °C	±1.1 °C or ²⁾ ±0.4 %

Type E

Class	Temperature range	Tolerance value
DIN EN 60584 part 2		
1	-40 ... +375 °C	±1.5 °C
1	+375 ... +800 °C	±0.0040 • t ¹⁾
2	-40 ... +333 °C	±2.5 °C
2	+333 ... +900 °C	±0.0075 • t ¹⁾

Type T

Class	Temperature range	Tolerance value
DIN EN 60584 part 2		
1	-40 ... +125 °C	±0.5 °C
1	+125 ... +350 °C	±0.0040 • t ¹⁾
2	-40 ... +133 °C	±1.0 °C
2	+133 ... +350 °C	±0.0075 • t ¹⁾

Type N

Class	Temperature range	Tolerance value
DIN EN 60584 part 2		
1	-40 ... +375 °C	±1.5 °C
1	+375 ... +1000 °C	±0.0040 • t ¹⁾
2	-40 ... +333 °C	±2.5 °C
2	+333 ... +1200 °C	±0.0075 • t ¹⁾

1) |t| is the value of the temperature in °C irrespective of the sign
2) Whichever is larger

Tolerance value with selected temperature in °C for thermocouples type K

Temperature (ITS 90) °C	Tolerance value DIN EN 60584 part 2	
	Class 1 °C	Class 2 °C
0	±1.50	±2.50
100	±1.50	±2.50
200	±1.50	±2.50
300	±1.50	±2.50
400	±1.60	±3.00
500	±2.00	±3.75
600	±2.40	±4.50
700	±2.80	±5.25
800	±3.20	±6.00
900	±3.60	±6.75
1000	±4.00	±7.50
1100	±4.40	±8.25
1200	±4.80	±9.00

Potential measuring uncertainties due to ageing effects

Thermocouples are subject to ageing and change their temperature/thermal voltage characteristic. Type J thermocouples of (Fe-Cu-Ni) age slightly due to oxidation of the pure metal leg. In types K and N thermocouples (NiCrSi-NiSi), high temperatures can result in substantial changes to the thermal voltage due to chrome depletion in the NiCr leg, leading to a lower thermal voltage.

This effect is accelerated if there is a shortage of oxygen, since a complete oxide layer, which would protect it from further oxidation, cannot be formed on the surface of the thermocouple. Chromium is oxidised, but nickel isn't. This results in the so-called "**green rot**", destroying the thermocouple. When NiCr-Ni thermocouples that have been operating above 700 °C are cooled quickly, this cooling causes certain states in the crystal structure (**short-range order**) to freeze, which in type K thermocouples can result in a change of the thermal voltage of up to 0.8 mV (K effect).

In Type N thermocouple (NiCrSi-NiSi), it has been possible to reduce the **short-range-order effect** by alloying both legs with silicon. The effect is reversible and is largely eliminated again by annealing above 700 °C, followed by slow cooling. Thin sheathed thermocouples are particularly sensitive. Cooling in still air can even result in deviations of more than 1 K.

Measuring insert

The measuring insert is made of a vibration-resistant, sheathed, mineral-insulated cable (MI cable). The diameter of the measuring insert should be approx. 1 mm smaller than the bore diameter of the thermowell. Gaps of more than 0.5 mm between thermowell and the measuring insert will have a negative effect on the heat transfer, and they will result in unfavourable response behaviour from the thermometer.

When fitting the measuring insert into a thermowell, it is very important to determine the correct insertion length (= thermowell length for bottom thicknesses of ≤ 5.5 mm). In order to ensure that the measuring insert is firmly pressed down onto the bottom of the thermowell, the insert must be spring-loaded (spring travel: 0 up to 19 mm).

The clearance, defined in the approval conditions, between the measuring insert and the neck tube acts as the flame-proof joint.

Neck tube

The neck tube is screwed into the connection head or the case. The neck length depends on the intended use. Usually an isolation is bridged by the neck tube.

Also, in many cases, the neck tube serves as a cooling extension between the connection head and the medium, in order to protect any possible built-in transmitter from high medium temperatures.

The standard material for neck tubes is stainless steel.

TC10-W components

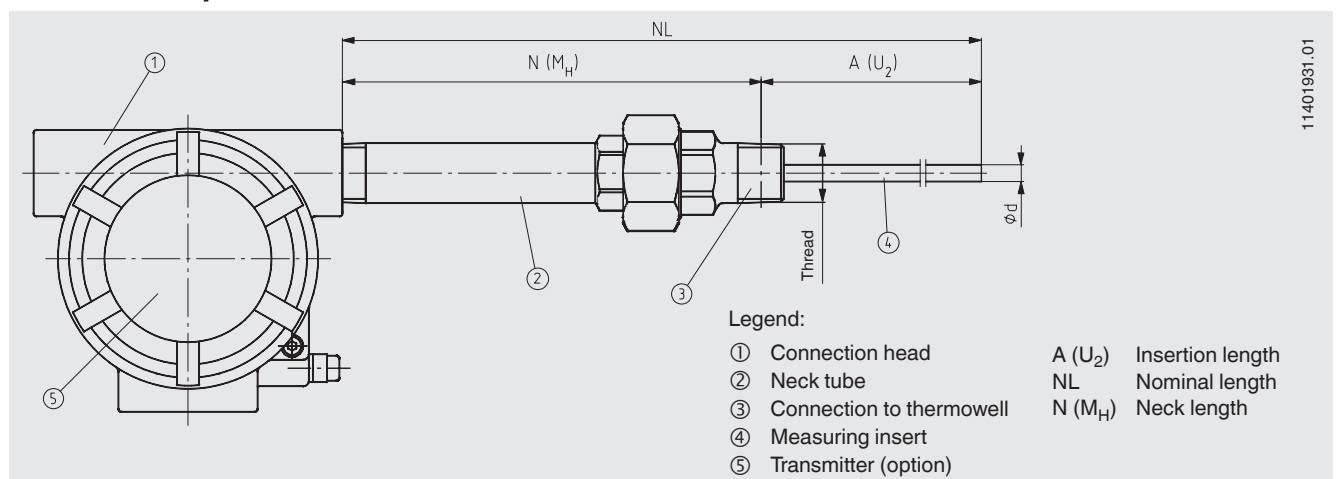

Connection to thermowell

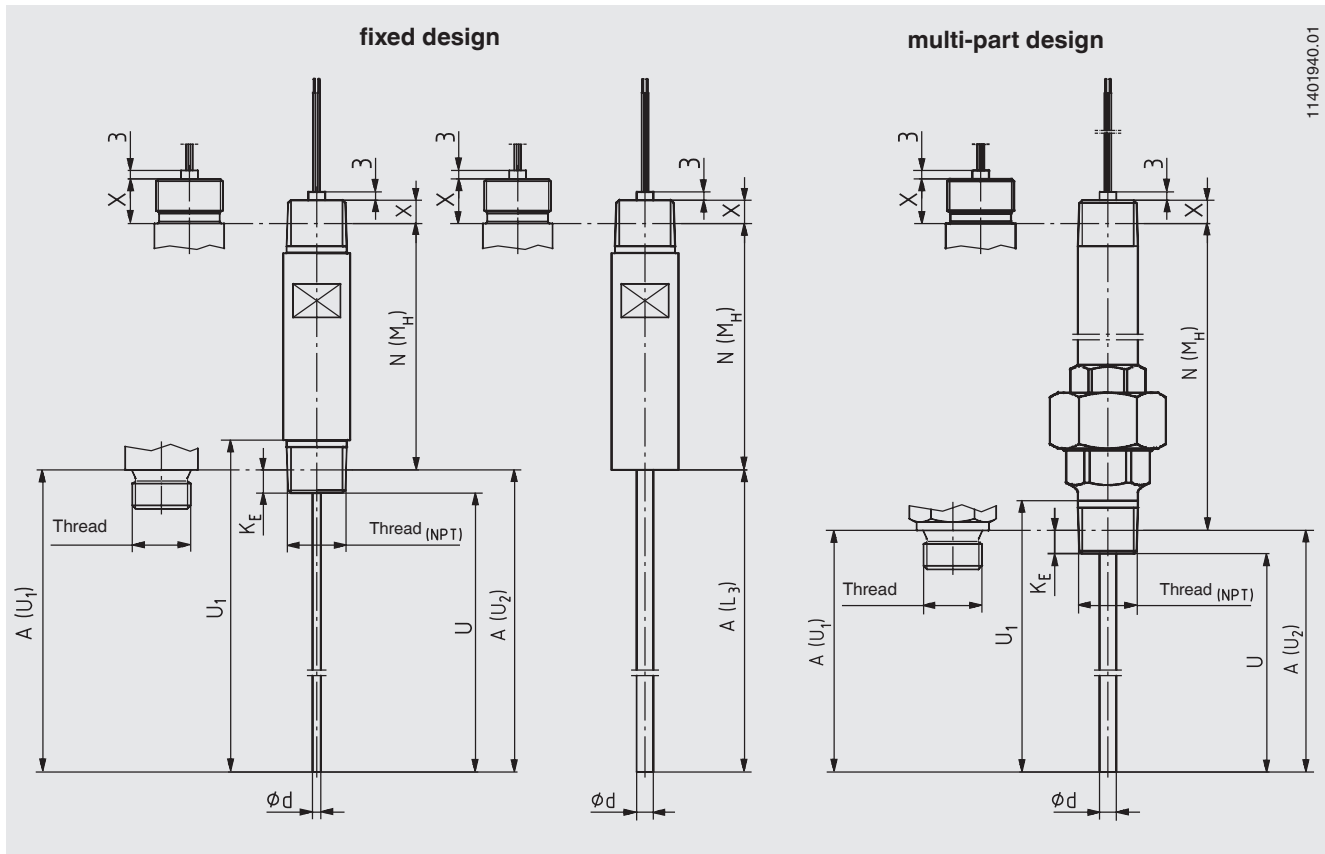

11401940.01

Possible thread sizes of the male thread at the neck tube

Thread to the thermowell
G 1/2 B
G 3/4 B
M14 x 1.5
M18 x 1.5
1/2 NPT
3/4 NPT

Thread to the head	X
1/2 NPT	8 mm
M20 x 1.5	14 mm

Connection head

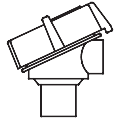

1000/4000

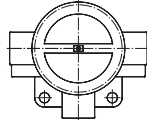

5000/6000

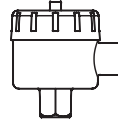

7000/8000

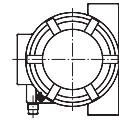

on request

Model	Material	Cable entry	Ingress protection	Cap	Surface finish
1000/4000	Aluminium	1/2 NPT, 3/4 NPT or M20 x 1.5	IP 65 ¹⁾	Screw cover	blue, painted ²⁾
1000/4000	Stainless steel	1/2 NPT, 3/4 NPT or M20 x 1.5	IP 65 ¹⁾	Screw cover	blank
5000/6000	Aluminium	1/2 NPT, 3/4 NPT or M20 x 1.5	IP 65 ¹⁾	Screw cover	blue, painted ²⁾
7000/8000	Aluminium	1/2 NPT, 3/4 NPT or M20 x 1.5	IP 65 ¹⁾	Screw cover	blue, painted ²⁾
7000/8000	Stainless steel	1/2 NPT, 3/4 NPT or M20 x 1.5	IP 65 ¹⁾	Screw cover	blank

1) The indicated ingress protection only applies for TC10-W with corresponding cable gland, appropriate cable dimensions and mounted thermowell.
 2) RAL5022

Field temperature transmitter with digital display (option)

Field temperature transmitter model TIF50-F

As an alternative to the standard connection head the thermometer can be fitted with an optional model TIF50-F field temperature transmitter.

The field temperature transmitter comprises a 4 ... 20 mA/ HART® protocol output and is equipped with an LCD indication module.



Field temperature transmitter model TIF50-F

Transmitter (option)

As an option, WIKA transmitters can be installed in the TC10-W connection head.

Model	Description	Explosion protection	Data sheet
T32	Digital transmitter, HART® protocol	optional	TE 32.04
T53	Digital transmitter FOUNDATION™ Fieldbus and PROFIBUS® PA	standard	TE 53.01
TIF50-F	Digital field temperature transmitter, HART® protocol	optional	TE 62.01

Further transmitters on request.

Explosion protection

Thermocouples of the TC10-W series are provided with a EC type examination certificate for "flameproof enclosure" ignition protection per directive 94/9/EC (ATEX), Ex-d, for gases.

Measuring insert, connection head (flameproof) and integrated flameproof joint guarantee safe operation.

The classification/suitability of the instrument for the respective category can be seen on the EC type-examination certificate and in the operating instructions.

Built-in transmitters have their own EC type-examination certificate. The permissible ambient temperature ranges of the built-in transmitters can be taken from the corresponding transmitter approval.

Functional safety (option)

In safety-critical applications, the entire measuring chain must be taken into consideration in terms of the safety parameters. The SIL classification allows the assessment of the risk reduction reached by the safety installations.

Selected TC10-W thermocouples in combination with an appropriate temperature transmitter (e.g. model T32.1S) are suitable as sensors for safety functions up to SIL 2.

Matched thermowells allow easy dismounting of the measuring insert for calibration. The optimally tuned measuring point consists of a thermowell, a TC10-W thermometer and a T32.1S transmitter developed in accordance with IEC 61508. Thus, the measuring point provides maximum reliability and a long service life.

Electrical connection

(Colour code per IEC 60584-2, ANSI MC96.1)

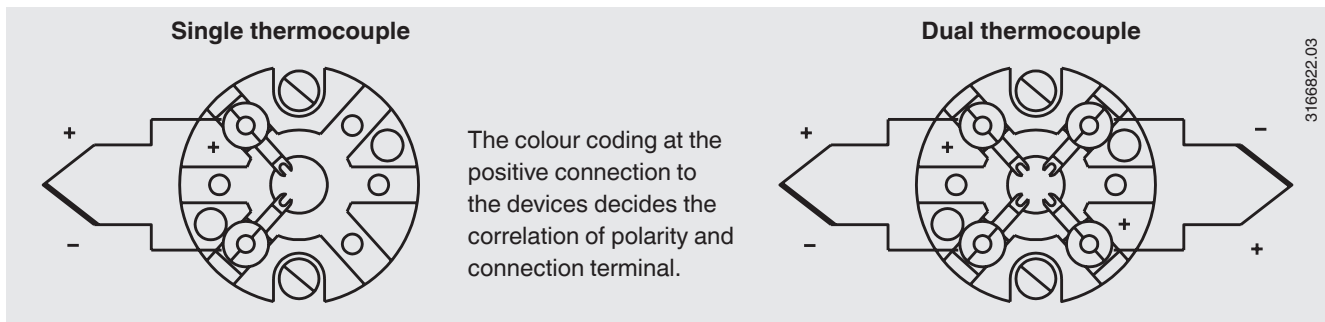

For the electrical connections of built-in temperature transmitters see the corresponding data sheets or operating instructions.

Ordering information

Model / Design measuring insert / Explosion protection / Flameproof / Connection head / Cable entry of the connection head / Female thread at connection head / Terminal block, transmitter / Process connection / Material neck tube / Design and material of the thread / Thread size / Measuring element / Connection method / Temperature range / Design of sensor tip / Sensor diameter / Insertion length A / Neck length N(MH) / Certificates / Options

© 2011 WIKA Alexander Wiegand SE & Co. KG, all rights reserved.
The specifications given in this document represent the state of engineering at the time of publishing.
We reserve the right to make modifications to the specifications and materials.

