

Hand-held pressure indicator

Model CPH6300-S1 (1-channel version)

Model CPH6300-S2 (2-channel version)

WIKA data sheet CT 12.01



for further approvals
see page 4 - 5

Applications

- Calibration service companies and service industry
- Measurement and control laboratories
- Quality assurance
- Leak testing

Special features

- Robust and waterproof digital indicator with interchangeable pressure sensors (plug-and-play)
- Measuring ranges from 0 ... 25 mbar to 0 ... 1,000 bar (0 ... 0.4 psi bis 0 ... 14,500 psi)
- Pressure type: positive and negative gauge pressure, absolute pressure and differential pressure
- Accuracy: 0.2 %, optional 0.1 % (incl. calibration certificate)
- Software and complete service cases (incl. pumps) available



Model CPH6300-S1 hand-held pressure indicator with model CPT6200 reference pressure sensor

Description

Extensive application possibilities

Stainless steel pressure sensors with measuring ranges up to 1,000 bar (14,500 psi) are available for the model CPH6300 hand-held pressure indicator. The robust and waterproof design makes the CPH6300 ideal for use in adverse environments. The digital indicator automatically detects the measuring range of the connected pressure sensor and guarantees a highly accurate pressure measurement.

Functionality

The CPH6300 can be used for measuring both gauge and absolute pressure. Differential pressure measurement is possible with the 2-channel version CPH6300-S2, and two connected model CPT6200 reference pressure sensors. Selectable pressure units here are bar, mbar, psi, Pa, kPa, MPa, mmHg, inHg, mH₂O and one customer-specific unit.

An integrated data logger and various other functions such as Min., Max., Hold, Tare, zero point adjustment, alarm, power-off, peak value detection (1,000 measurements/s), average value filter, etc. ensure that the CPH6300 can be used for many different applications. The large, backlit display and also a long battery life complete the features of the CPH6300.

Software

In addition to the GSoft data logger evaluation software for the tabular and graphical representation of the logged data, WIKA-Cal calibration software for calibration tasks is also available. WIKA-Cal also offers, over and above PC-supported calibration, the management of the calibration and instrument data in an SQL database. A USB interface is available for the data transfer.

Complete test and service cases

For maintenance and service applications, various case systems are available. These include service cases with or without pressure generation, rechargeable battery, battery charger, connection adapter, etc.

Certified accuracy

For each reference pressure sensor, the accuracy for the complete measuring chain is certified by a factory calibration certificate which accompanies the instrument. On request, we can provide a DKD/DAkkS calibration certificate for this instrument.

Specifications

Model CPH6300 hand-held pressure indicator (complete measuring chain)						
Measuring inputs	1 input for CPH6300-S1 2 inputs for CPH6300-S2					
Measuring range						
Gauge pressure	mbar	-600 ... 0	-600 ... +600	-400 ... 0	-400 ... +400	-250 ... 0
		-250 ... +250	-100 ... +100	-20 ... 60	-20 ... 40	-20 ... 25
		0 ... 25	0 ... 40	0 ... 60	0 ... 100	0 ... 160
		0 ... 250	0 ... 400	0 ... 600		
	bar	-1 ... 0	-1 ... 1,5	-1 ... 3	-1 ... 5	-1 ... 9
		-1 ... 15	-1 ... 24	-1 ... 39	0 ... 1	0 ... 1.6
		0 ... 2.5	0 ... 4	0 ... 6	0 ... 10	0 ... 16
		0 ... 25	0 ... 40	0 ... 60	0 ... 70	0 ... 100
		0 ... 160	0 ... 250	0 ... 400	0 ... 600	0 ... 1,000
	psi	0 ... 0.4	0 ... 0.6	0 ... 0.9	0 ... 1.5	0 ... 2.5
		0 ... 4	0 ... 6	0 ... 10	0 ... 14.5	0 ... 25
		0 ... 40	0 ... 60	0 ... 90	0 ... 145	0 ... 250
		0 ... 360	0 ... 580	0 ... 870	0 ... 1,450	0 ... 2,320
		0 ... 3,630	0 ... 5,800	0 ... 8,700	0 ... 14,500	
	Absolute pressure	mbar abs.	0 ... 250	0 ... 400	0 ... 600	
bar abs.		0 ... 1	0 ... 1.6	0 ... 2.5	0 ... 4	0 ... 6
		0 ... 10	0 ... 16	0 ... 25	0.8 ... 1.2	
Overpressure limit	3 times; ≤ 25 bar 2 times; > 25 bar ... ≤ 600 bar 1.5 times; > 600 bar			3 times; ≤ 360 psi 2 times; > 360 psi ... ≤ 8,700 psi 1.5 times; > 8,700 psi		
Resolution	dependant on pressure range (max. 4 1/2-digit)					
Accuracy of the measuring chain ¹⁾	0.2 % FS (resolution 4-digit); {optional: 0.1 % FS (resolution 4 1/2-digit)} ²⁾					
Types of pressure	Gauge pressure, {absolute pressure from 0 ... 25 bar abs. (0 ... 360 psi abs.) and vacuum from -1 ... +39 bar (-14.5 ... 550 psi)} Differential pressure measuring only with CPH6300-S2 and two model CPT6200 reference pressure sensors connected possible					
Sensor compatibility	Compatible with model CPT6200 reference pressure sensors					

{ } Items in curved brackets are optional extras for an additional price.

1) It is defined by the total measurement uncertainty, which is expressed with the coverage factor (k = 2) and includes the following factors: the intrinsic performance of the instrument, the measurement uncertainty of the reference instrument, long-term stability, influence of ambient conditions, drift and temperature effects over the compensated range during a periodic zero point adjustment.

2) Reference conditions: 15 ... 25 °C (59 ... 77 °F)

Digital indicator model CPH6300**Indication**

Display	Large 4 1/2-digit LC display with backlighting for indication of two pressure values and additional information
Indication range	-19999 ... 19999 digits, depending on sensor used
Pressure units	bar, mbar, psi, Pa, kPa, MPa, mmHg, inHg, mH ₂ O and a customer-specific unit, pre-set to kg/cm ² (depending on the measuring range, freely selectable)

Functions

Measuring rate	4/s ("slow"); 1,000/s ("fast"); > 1,000/s unfiltered (peak value detection), selectable
Memory	Min./Max., integrated data logger
Functions via button press	Backlighting, Min./Max. memory, Hold, Tare, zero-point adjustment, Logger (start/stop)
Menu functions	Min./Max. alarm (acoustic/visual), sea level (barometric air pressure), power-off function, measuring rate, mean value filter
Mean value filter	1 ... 120 seconds, adjustable
Data logger	Individual value logger: Up to 1,000 recordings (with measuring point input, 40 settable measuring point texts or measuring point nos.) incl. time via button press Cyclic logger: Automatic recording of up to 10,000 values incl. time Cycle time: Selectable from 1 ... 3,600 seconds
Real-time clock	integrated clock with date
Leak testing/sealing tests	Pressure rate display, logging via data logger

Voltage supply

Power supply	2 x 1.5 V AAA batteries
Battery life	> 500 hours of operation (1 sensor with a measuring rate of 4/s)
Battery status indication	Icon in display

Permissible ambient conditions

Operating temperature	-25 ... +50 °C (-13 ... +122 °F)
Storage temperature	-25 ... +70 °C (-13 ... +158 °F)
Relative humidity	0 ... 95 % r. h. (non-condensing)

Communication

Interface	USB via interface cable
Analogue output	DC 0 ... 1 V; configurable (selectable via menu alternative to interface)

Case

Material	impact-resistant ABS plastic, membrane keyboard, transparent screen, silicone protective casing
Ingress protection	IP65, IP67 (both ingress protection types are met)
Electrical connection	Sensor cable: Bayonet connector, 7-pin Interface connector: Bayonet connector, 4-pin
Dimensions	See technical drawings
Weight	approx. 250 g (0.55 lbs) (incl. batteries and protective casing)

Reference pressure sensor model CPT6200

Pressure connection ⁴⁾	G ½ B; {flush (G 1 for 0.1 ... 1.6 bar (1.5 ... 25 psi)) or various connection adapters on request}
Material	
Wetted parts	Stainless steel or Elgiloy®, (> 25 bar (360 psi) additionally with NBR seal) ³⁾ Flush diaphragm version: Stainless steel {Hastelloy C4}; O-ring: NBR {FKM/FPM or EPDM}
Internal transmission fluid	Synthetic oil (only for measuring ranges to 16 bar (250 psi) or flush diaphragm) {Halocarbon oil for oxygen applications}; {Listed by FDA for food industry}
Sensor specifications	
Accuracy ¹⁾	≤ 0.2 % of span at reference conditions ²⁾
Compensated range	0 ... 80 °C (0 ... 176 °F)
Mean temperature coefficient	≤ 0.2 % of span/10 K (outside of reference conditions)
Permissible ambient conditions	
Medium temperature ⁴⁾	-30 ... +100 °C (-22 ... +212 °F) ⁵⁾
Operating temperature	-20 ... +80 °C (-4 ... +176 °F)
Storage temperature	-40 ... +100 °C (-40 ... +212 °F) ⁵⁾
Humidity	0 ... 95 % r. h. (non-condensing)
Case	
Material	Stainless steel
Connection to the CPH6300	Standard: via 1 m (3.3 ft) connection cable (plug-and-play) Optional: up to 5 m (16.4 ft)
Ingress protection	IP67
Dimensions	See technical drawing
Weight	approx. 220 g (0.49 lbs)

{ } Items in curved brackets are optional extras for an additional price.

1) It is defined by the total measurement uncertainty, which is expressed with the coverage factor (k = 2) and includes the following factors: the intrinsic performance of the instrument, the measurement uncertainty of the reference instrument, long-term stability, influence of ambient conditions, drift and temperature effects over the compensated range during a periodic zero point adjustment.







2) Reference conditions: 15 ... 25 °C (59 ... 77 °F)

3) For pressure measuring ranges 0 ... 25 mbar, 0 ... 40 mbar and 0 ... 60 mbar (0 ... 0.4 psi, 0 ... 0.6 psi and 0 ... 0.9 psi) all wetted parts are made of stainless steel, silicon, aluminium, gold, silicone.

4) As an oxygen version, a flush diaphragm model is not available. In an oxygen version, the model CPT6200 is only available in overpressure ranges ≥ 0.25 bar (≥ 0.4 psi), with media temperatures between -10 ... +50 °C (14 ... 122 °F) and using stainless steel or Elgiloy® wetted parts.

5) For pressure measuring ranges 0 ... 25 mbar, 0 ... 40 mbar and 0 ... 60 mbar (0 ... 0.4 psi, 0 ... 0.6 psi and 0 ... 0.9 psi) the medium temperature and storage temperature are limited to +80 °C (176 °F).

Approvals

Logo	Description	Country
	EU declaration of conformity for CPH6300 ■ EMC directive EN 61326 emission (group 1, class B) and interference immunity (portable equipment) ■ RoHS directive	European Union
	EU declaration of conformity for CPT6200 ■ EMC directive EN 61326 emission (group 1, class B) and interference immunity (portable equipment) ■ Pressure equipment directive PS > 200 bar, module A, pressure accessory ■ RoHS directive	European Union
	EAC ■ EMC directive ■ Pressure equipment directive	Eurasian Economic Community
	GOST Metrology, measurement technology	Russia
	KazInMetr Metrology, measurement technology	Kazakhstan
-	MTSCHS Permission for commissioning	Kazakhstan
	BelGIM Metrology, measurement technology	Belarus

Logo	Description	Country
	UkrSEPRO Metrology, measurement technology	Ukraine
	Uzstandard Metrology, measurement technology	Uzbekistan

Certificates

Certificate	
Calibration	Standard: 3.1 calibration certificate per DIN EN 10204 Option: DKD/DAkkS calibration certificate
Recommended recalibration interval	1 year (dependent on conditions of use)

Approvals and certificates, see website

Dimensions in mm (in)

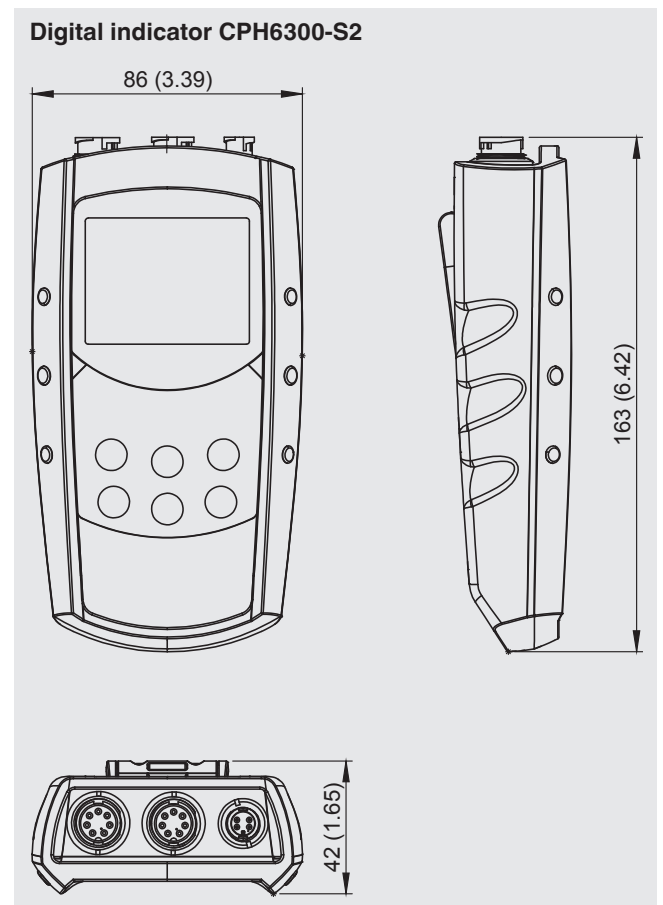
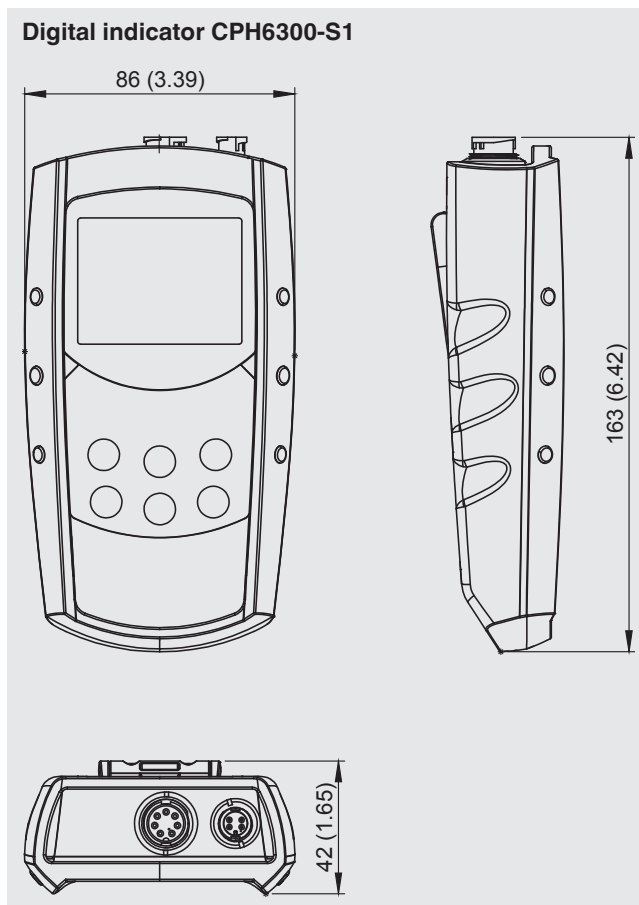

Dimensions in mm (in)

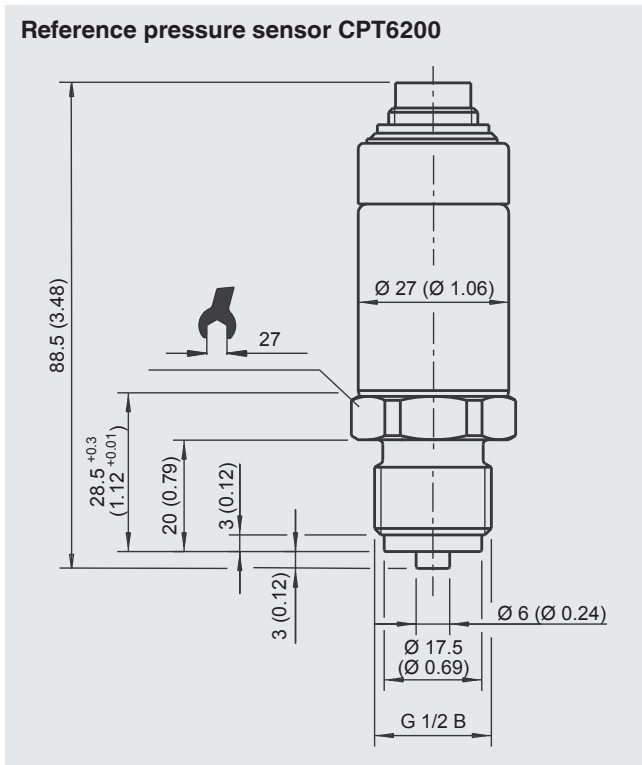

Electrical connections

Model CPH6300-S1

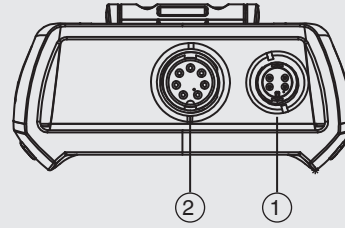

Model CPH6300-S2

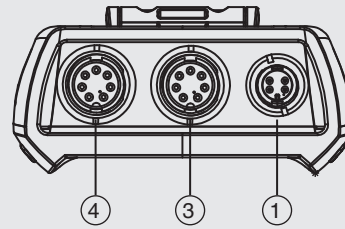

- ① Connection for interface adapter
- ② Connection channel 1 (only with CPH6300-S1)
- ③ Connection channel 2 (only with CPH6300-S2)
- ④ Connection channel 1 (only with CPH6300-S2)

Operation of the models CPH6300-S1 and CPH6300-S2

1- and 2-channel version with external pressure sensors

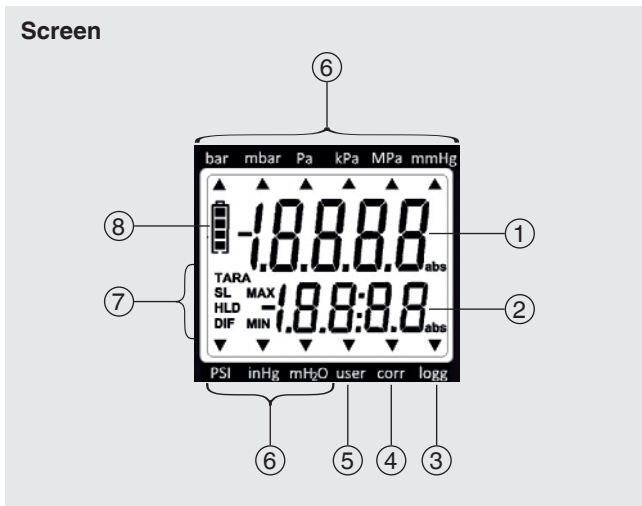

- ① **Main display:** Current measured value for sensor 1
- ② **Secondary display:** Current measured value for sensor 2 or differential value between sensor 1 and sensor 2
- ③ **Logg arrow:** Logger is ready
Arrow blinking: Automatic recording (Logg CYCL) active
- ④ **Corr arrow:** Zero point or slope correction has been made
- ⑤ **User arrow:** Measured value is specified in the freely-configurable user unit
- ⑥ Display arrows for **measured value units**
- ⑦ Indication elements for Min./Max. measured values, as well as the Tare function and sea-level correction
- ⑧ Battery status indication

Keyboard

	Instrument on
	Illumination on
2 sec.	Instrument off

	MAX function on/off
2 sec.	Delete MAX value

	TARE function on
2 sec.	TARE function off
5 sec.	Zero-point adjustment on
10 sec.	Zero-point adjustment off

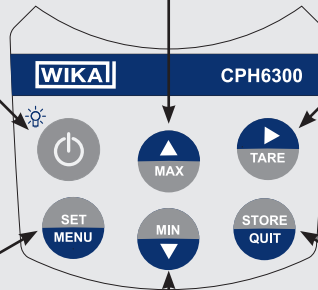

	Change the secondary display CH1 <-> CH2 <-> DIF (only for 2-channel)
2 sec.	Main menu Enter configuration

	MIN function on/off
2 sec.	Delete MIN value

	Hold function on/off	if: A
	Store measured value	
2 sec.	Clear memory?	B
2 sec.	Store cyclically	
2 sec.	Stop storage?	C
2 sec.	Clear memory?	

= Press button
 2 sec. = Press button for 2 seconds
 For more information: See operating instructions

A = Logger functions deactivated
 B = Logger function "Store measured value" activated via menu
 C = Logger function "Store cyclically" activated via menu

Complete test and service cases

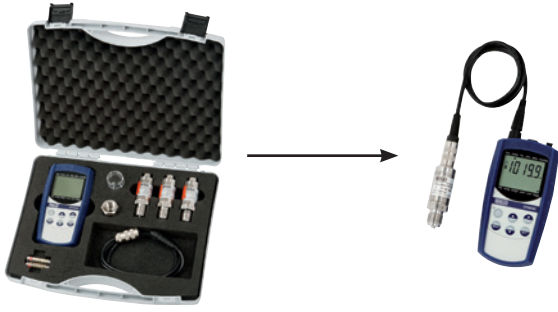

Calibration case with model CPH6300 hand-held pressure indicator for pressure, consisting of:

- Plastic service case with foam insert
- Hand-held pressure indicator model CPH6300
- Two AAA batteries
- Sealing set
- Sensor cable
- Spaces for several CPT6200 reference pressure sensors

Available measuring ranges see specifications

Basic version

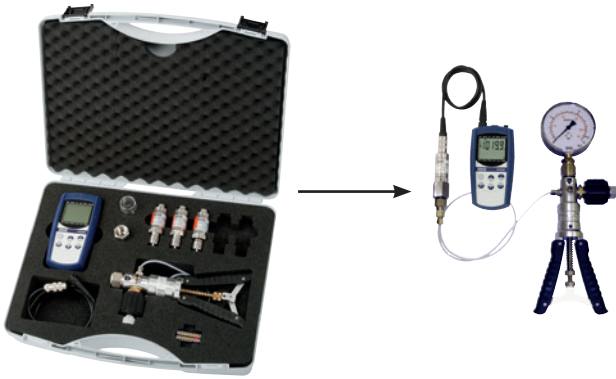

Calibration case with model CPH6300 hand-held pressure indicator and model CPP30 hand test pump for pressures of -0.95 ... +35 bar (-28 inHg ... 500 psi), consisting of:

- Plastic service case with foam insert
- Hand-held pressure indicator model CPH6300
- Pneumatic hand test pump model CPP30; -0.95 ... +35 bar (-28 inHg ... 500 psi)
- Sealing set
- Sensor cable
- Spaces for several CPT6200 reference pressure sensors

Available measuring ranges see specifications

Basic version incl. pneumatic pressure generation



Calibration case with model CPH6300 hand-held pressure indicator and model CPP700-H or CPP1000-H hand test pump for pressures of 0 ... 700 bar or 0 ... 1,000 bar (0 ... 10,000 psi or 0 ... 14,500 psi), consisting of:

- Plastic service case with foam insert
- Hand-held pressure indicator model CPH6300
- Hydraulic hand test pump model CPP700-H or CPP1000-H, 0 ... 700 bar or 0 ... 1,000 bar (0 ... 10,000 psi or 0 ... 14,500 psi)
- Sealing set
- Sensor cable
- Spaces for several CPT6200 reference pressure sensors

Available measuring ranges see specifications

Basic version incl. hydraulic pressure generation

GSoft data logger evaluation software

The GSoft data logger evaluation software is used to display the logger data of the model CPH6300 hand-held pressure indicator on a PC in tabular form and as chart.

- Easy operation with self-explanatory toolbars
- Data from the pressure and temperature hand-helds (CTH6200) can be displayed in a single chart (two separate y-axes)
- Chart offers a zoom function
- Operation of the logger function via PC (remote control)
- Data can be exported (Excel®, etc.)
- Languages: German, English, French, Spanish and Czech

System requirements

- IBM compatible PC (Pentium®)
- At least 20 MB free hard disc space
- CD-ROM drive
- At least 32 MB RAM
- Windows® operating system 95, 98, NT 4.0 (with Service Pack 3.0 or higher), 2000, XP, Vista or 7
- Mouse
- USB port (via interface cable)

To operate the GSoft software with the CPH6300, GSoft version 3.0 or later is needed.

Free updates are available for download on www.wika.com.

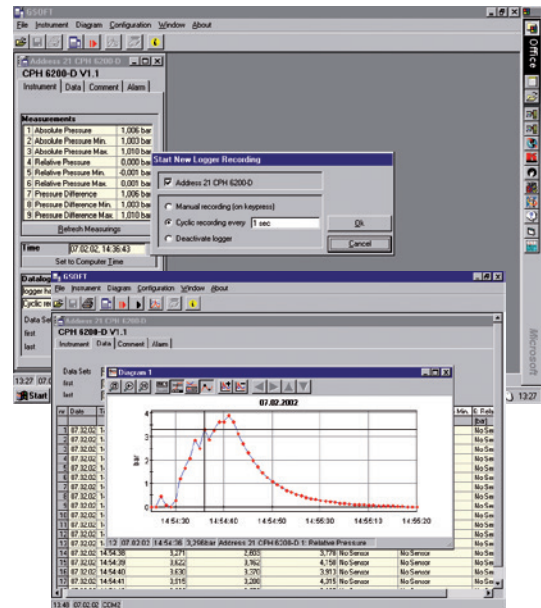

Data export e.g. in an Excel® file

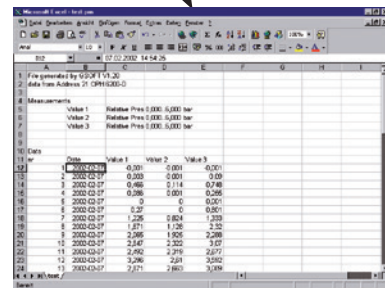

Windows® is a registered trademark of Microsoft Corporation in the United States and other countries.

Easy operation with self-explanatory icon buttons

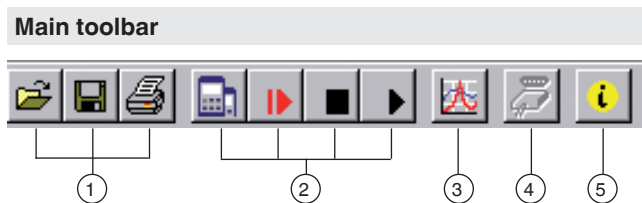

- ① File functions: Open, save, print
- ② Logger functions: Start communication, start logger, stop, read data
- ③ Data display: Create chart
- ④ Interface configuration
- ⑤ Program information
- ⑥ Settings: Grid and colour settings, manual zooms

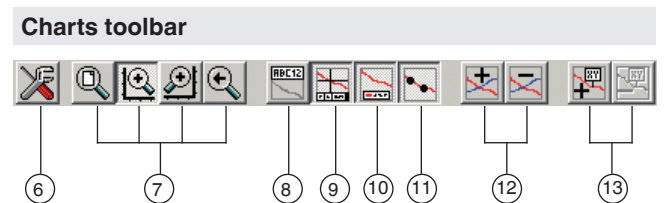

- ⑦ Zoom: All, left or right y-axis (via mouse), back
- ⑧ Rename chart
- ⑨ Cursor on/off (Info footer)
- ⑩ Legend on/off
- ⑪ (Measuring point) Symbols on/off
- ⑫ Measurement series (add/delete)
- ⑬ Comments on measuring points (add/delete)

WIKA-Cal calibration software

Easy and fast creation of a high-quality calibration certificate

The WIKA-Cal calibration software is used for generating calibration certificates or logger protocols for pressure measuring instruments and is available as a demo version for a cost-free download.

A template helps the user and guides him through the creation process of a document.

In order to switch from the demo version to a full version of the respective template, a USB stick with the template has to be purchased.

The pre-installed demo version automatically changes to the selected full version when the USB stick is inserted and remains available as long as the USB stick is connected to the computer.



- Creation of calibration certificates for mechanical and electronic pressure measuring instruments
- A calibration assistant guides you through the calibration
- Automatic generation of the calibration steps
- Generation of 3.1 certificates per DIN EN 10204
- Creation of logger protocols
- User-friendly interface
- Languages: German, English, Italian and more due with software updates

For further information see data sheet CT 95.10

Calibration certificates can be created with the Cal-Template and logger protocols can be created with the Log-Template.



Cal Demo

Generation of calibration certificates limited to 2 measuring points, with automatic initiation of pressures via a pressure controller.



Cal Light

Generation of calibration certificates with no limitations on measuring points, without automatic initiation of pressures via a pressure controller.



Log Demo

Creation of data logger test reports, limited to 5 measured values.



Log

Creation of data logger test reports without limiting the measured values.

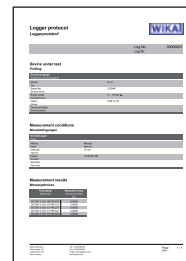
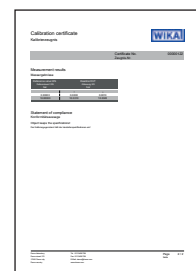
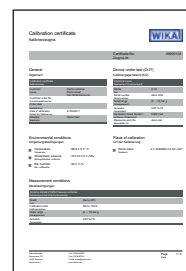

Accessories	Order code
2 AAA rechargeable batteries	CPH-A-63-ZAZZZZZZZZ-Z
2 AAA batteries	CPH-A-63-ZBZZZZZZZZ-Z
Charger for 9 V rechargeable battery and 2 rechargeable AAA batteries (Euro standard)	CPH-A-63-Z1ZZZZZZZZ-Z
Charger for 9 V rechargeable battery and 2 rechargeable AAA batteries (UK standard)	CPH-A-63-Z2ZZZZZZZZ-Z
Charger for 9 V rechargeable battery and 2 rechargeable AAA batteries (US standard)	CPH-A-63-Z3ZZZZZZZZ-Z
Sealing set, consisting of 4 x G ½ USIT seals, 2 x G ¼ USIT seals and plastic box	CPH-A-63-ZDZZZZZZZZ-Z
Sensor connection cable, approx. 1.1 m (3.3 ft)	CPH-A-63-ZSZZZZZZZZ-Z
Extension cable for connection of sensors, approx. 3.8 m (12.5 ft) to approx. 5 m (16.4 ft)	CPH-A-63-ZVZZZZZZZZ-Z
2 connection cable, 2 m (6.6 ft) with loose ends (sleeves) for connecting the configurable analogue output	CPH-A-63-ZEZZZZZZZZ-Z
USB interface cable	CPH-A-63-ZUZZZZZZZZ-Z
Gsoft data logger evaluation software	CPH-A-63-ZGZZZZZZZZ-Z
Plastic case for 1 x hand-held, 3 x pressure sensors, accessories	CPH-A-63-ZKZZZZZZZZ-Z
Plastic case for 1 x hand-held, 5 x pressure sensors, 1 x pneumatic hand test pump CPP7-H or CPP30, accessories	CPH-A-63-ZLZZZZZZZZ-Z
Plastic case for 1 x hand-held, 4 x pressure sensors, 1 x hydraulic hand test pump CPP700-H/ CPP1000-H, accessories	CPH-A-63-ZNZZZZZZZZ-Z

Scope of delivery

- Hand-held pressure indicator model CPH6300-S1 incl. two AAA batteries
- One sensor connection cable per channel
- 3.1 calibration certificate per DIN EN 10204
- Choice of sensors

Options

- Hand-held pressure indicator model CPH6300-S2: 2-channel version (differential pressure measurement possible via two connected model CPT6200 reference pressure sensors)
- DKD/DAkS calibration certificate
- Sensors for oxygen applications



Model CPH6300-S2 hand-held pressure indicator with two model CPT6200 reference pressure sensors

Ordering information

CPH6300 / Instrument version / Additional cable for reference pressure sensor / Rechargeable battery and battery charger / Software / Interface cable / Test pump / Carrying case / Further approvals / Additional order information

CPT6200 / Unit / Pressure range / Accuracy / Process connection / Special design features / Type of certificate / Further approvals / Additional order information

© 03/2012 WIKA Alexander Wiegand SE & Co. KG, all rights reserved.
The specifications given in this document represent the state of engineering at the time of publishing.
We reserve the right to make modifications to the specifications and materials.

